

STORAGE OF CLASS 1, 2, 3, 4 AND PLASTIC COMMODITIES

Table of Contents

	Page
1.0 SCOPE	5
1.1 Changes	5
1.2 Superseded Information	6
1.3 How to Use This Data Sheet	6
2.0 LOSS PREVENTION RECOMMENDATIONS	9
2.1 Construction and Location	9
2.1.1 General	9
2.1.2 Steel Column Protection	9
2.1.3 Heat and Smoke Venting and Draft Curtains	9
2.1.3.1 Heat and Smoke Venting	9
2.1.3.2 Draft Curtains	9
2.2 Occupancy	9
2.2.1 General	9
2.2.2 Commodity Hazard	10
2.2.3 Flue Spaces	10
2.2.3.1 Flue Spaces for Rack Storage Protected by Ceiling-Level Sprinklers Only	10
2.2.3.2 Flue Spaces for Rack Storage Protected by both Ceiling-Level and In-Rack Sprinklers	11
2.2.4 Pallets	11
2.2.5 Special Storage Considerations	11
2.2.5.1 Open-Top Containers Maintained in Storage Racks	11
2.2.5.2 Portable Racks	12
2.2.5.3 Movable Racks	13
2.2.6 Clearance Between Top of Storage and Ceiling-Level Sprinkler Deflector	13
2.3 Protection	13
2.3.1 General	13
2.3.2 Sprinkler System Types	14
2.3.3 Ceiling-Level Storage Sprinklers	14
2.3.3.1 General	14
2.3.3.2 K-Factors, Nominal Temperature Rating, RTI Rating, and the Orientation of Ceiling-Level Storage Sprinklers	14
2.3.3.3 Spacing of Ceiling-Level Storage Sprinklers	15
2.3.3.4 Minimum Recommended Pressures for Ceiling-Level Storage Sprinklers	16
2.3.3.5 Extension of Hydraulic Design	16
2.3.3.6 Mixing Different Ceiling-Level Storage Sprinklers Within the Same Protected Area ..	16
2.3.3.7 Ceiling-Level Sprinkler System Design Criteria	16
2.3.4 In-Rack Sprinklers (IRAS)	27
2.3.4.1 General	27
2.3.4.2 When In-Rack Sprinklers are Needed	28
2.3.4.3 K-Factors, Nominal Temperature Rating, and RTI Rating of In-Rack Storage Sprinklers	30
2.3.4.4 In-Rack Sprinkler System Types	30
2.3.4.5 General Guidelines for Positioning of In-Rack Sprinklers	30
2.3.4.6 Horizontal Lay-Outs of In-Rack Sprinklers	30
2.3.4.7 Vertical Increments of In-Rack Sprinklers	43
2.3.4.8 Design Guidelines for Ceiling-Level and In-Rack Sprinklers	45
2.3.4.9 Design Guidelines for Fire Protection Scheme 8-9A	46



2.3.5	Hose Demands, Hose Connections, and System Duration	50
2.3.5.1	Hose Demand and System Duration	50
2.3.5.2	Hose Connections	51
2.3.6	Special Applications	51
2.3.6.1	Ceiling-Only Sprinkler Protection for Class 1, 2 and 3 Commodities Protected by Dry-Pipe and Similar Sprinkler Systems for Ceiling Heights Over 30 ft (9.0 m)	51
2.3.6.2	Retail/Big-Box Warehouse Occupancies	54
2.3.6.3	Protection of Class 1, 2, 3, 4 and Cartoned Plastics in Open-Frame Single and Double-Row Racks Using In-Rack Sprinklers Only in the Longitudinal Flue Space	54
2.3.6.4	Protection of Class 1, 2, 3, 4, Cartoned Plastics and Uncartoned Unexpanded Plastics in Single and Double-Row Racks Using a Combination of Longitudinal In-Rack Sprinklers and Horizontal Barriers	55
2.3.6.5	Protection of Class 1, 2, 3, 4 and Unexpanded (Cartoned and Uncartoned) Plastics in Open-Frame Storage Racks Using K14.0 (K200) and Larger, Quick-Response, Pendent Ceiling-level Sprinklers for Ceiling Heights up to 45 ft (13.5 m) High	56
2.3.6.6	Alternative In-Rack Sprinkler Designs	56
2.3.6.7	Retrofit In-Rack Sprinkler Protection Solution for Uncartoned Unexpanded Plastics Stored in Single-Row Racks Wider than 3 ft (0.9 m) or in Double-Row Racks Protected by In-Rack Sprinklers Installed Only in the Longitudinal Flue Space	60
2.3.6.8	K25.2EC (K360EC) Pendent In-Rack Sprinkler Protection of Class 1, 2, 3, 4 and Cartoned Unexpanded Plastics in Open-Frame Racks in Combination with Horizontal Barriers	63
2.3.6.9	Ceiling-Only Sprinkler Protection Recommendations for Ceiling Heights Over 40 ft (12.0 m)	66
3.0	SUPPORT FOR RECOMMENDATIONS	68
3.1	General	68
3.2	Loss History	68
3.3	Illustrative Losses	69
3.3.1	Roll Cloth in Racks Obstruct Flue Spaces, Resulting in Extensive Fire and Water Damage	69
3.3.2	Many Loss Prevention Principles Compromised in Warehouse Fire	69
3.3.3	Inadequate Sprinkler Protection Unable to Control Fire Involving Aisle Storage and Racks with Solid Shelves	69
3.3.4	Fire in High Rack-Storage Controlled by In-Rack Sprinklers	69
3.3.5	Lack of In-Rack Sprinklers for Racks With Solid Shelves Results in Extensive Fire Damage	69
3.3.6	Open-Top Containers in Racks Interfere with Sprinkler Water Penetration Resulting in Uncontrolled Fire	69
3.3.7	Poor Housekeeping Leads to Excessive Fire Spread	70
3.3.8	Strong Water Supply Overcomes Plugged Sprinklers	70
4.0	REFERENCES	70
4.1	FM Global	70
APPENDIX A GLOSSARY OF TERMS		70
APPENDIX B DOCUMENT REVISION HISTORY		82

List of Figures

Fig. 1.	Flowchart for determining the protection options for solid-piled, palletized, shelf, and bin-box storage arrangements	7
Fig. 2.	Flowchart for determining the protection options available for rack storage arrangements	8
Fig. 3.	Flowchart for evaluating the need for in-rack sprinklers	29
Fig. 4.	Recommended horizontal in-rack sprinkler arrangements for single-row racks	32
Fig. 5.	Recommended horizontal in-rack sprinkler arrangements for double-row racks	33
Fig. 6.	Recommended horizontal IRAS(E) in-rack sprinkler arrangements for double-row racks	34
Fig. 7.	Recommended horizontal in-rack sprinkler arrangements for multiple-row racks	35
Fig. 8.	Plan view of IRAS(EO) in-rack sprinkler arrangement for single-row racks	36
Fig. 9.	Plan view of IRAS(EO) in-rack sprinkler arrangement for double-row racks	37
Fig. 10.	Plan view of IRAS(EO) in-rack sprinkler arrangement for multiple-row racks	38
Fig. 11.	Plan view of IRAS(E) in-rack sprinkler arrangement for single-row racks	39
Fig. 12.	Plan view of IRAS(E) in-rack sprinkler arrangement in longitudinal flue only for double-row racks	40

Fig. 13. Plan view of IRAS(E) in-rack sprinkler arrangement for double-row racks	41
Fig. 14. Plan view of IRAS(E) in-rack sprinkler arrangement for multiple-row racks	42
Fig. 15. Recommended vertical in-rack sprinkler increments	44
Fig. 16. Fire Protection Scheme 8-9A within single-row racks	48
Fig. 17. Fire Protection Scheme 8-9A within double-row racks	49
Fig. 18. Fire Protection Scheme 8-9A within multiple-row racks	50
Fig. 19a. Plan view of alternative in-rack sprinkler arrangement for single-row racks up to 3 ft (0.9 m) deep .	57
Fig. 19b. Plan view of alternative in-rack sprinkler arrangement for single-row racks up to 6 ft (1.8 m) deep .	57
Fig. 19c. Plan view of alternative in-rack sprinkler arrangement for single-row racks up to 6 ft (1.8 m) deep located against wall	57
Fig. 20a. Plan view of alternative in-rack sprinkler arrangement for double-row racks up to 9 ft (2.7 m) deep	58
Fig. 20b. Plan view of alternative in-rack sprinkler arrangement for double-row racks up to 12 ft (3.7 m) deep	58
Fig. 21. Plan view of alternative in-rack sprinkler arrangement for multiple-row racks	58
Fig. 22. Determining ceiling height in applicable protection table	60
Fig. 23. Protection of uncartoned plastics in open-frame, single-row racks over 3 ft (0.9 m) and up to 6 ft (1.8 m) deep	61
Fig. 24. Protection of uncartoned plastics in open-frame, double-row racks up to 9 ft (2.7 m) deep	62
Fig. 25. Vertical distance between ceiling and centerline of sprinkler's thermal element in the presence of mineral wool or glass fiber batt insulation.	66
Fig. A-1. Typical double-row (back-to-back) rack arrangement	72
Fig. A-2. Typical wooden pallets	75
Fig. A-3. Open-frame double-row racks	76
Fig. A-4. Double-row racks with solid shelvess	77
Fig. A-5. Double-row racks with slatted shelves	77
Fig. A-6. Automatic storage rack	78
Fig. A-7. Multiple-row rack	78
Fig. A-8. Flow-through pallet rack	79
Fig. A-9. Drive-in rack, two or more pallets deep	79
Fig. A-10. Flow-through and portable racks	80
Fig. A-11. Cantilever rack	80
Fig. A-12. Example arrangement of an inspector's test connection for a dry sprinkler system design using 2 sprinklers on the most remote branchline	81
Fig. A-13. Example arrangement of an inspector's test connection for a dry sprinkler system design using 2 sprinklers on the most remote 2 branchlines (4 sprinklers total)	81

List of Tables

Table 1. Spacing of Ceiling-Level Storage Sprinklers Under Unobstructed Ceiling Construction	15
Table 2. Ceiling-Level Protection Guidelines for Class 1, 2, and 3 Commodities in a Solid-Piled, Palletized, Shelf, or Bin-Box Storage Arrangement	19
Table 3. Ceiling-Level Protection Guidelines for Class 4 and Cartoned Unexpanded Plastic Commodities in a Solid-Piled, Palletized, Shelf, or Bin-Box Storage Arrangement	20
Table 4. Ceiling-Level Protection Guidelines for Cartoned Expanded Plastic Commodities in a Solid-Piled, Palletized, Shelf, or Bin-Box Storage Arrangement	21
Table 5. Ceiling-Level Protection Guidelines for Uncartoned Unexpanded Plastic Commodities in a Solid-Piled, Palletized, Shelf, or Bin-Box Storage Arrangement	22
Table 6. Ceiling-Level Protection Guidelines for Uncartoned Expanded Plastic Commodities in a Solid-Piled, Palletized, Shelf or Bin-Box Storage Arrangement	22
Table 7. Ceiling-Level Protection Guidelines for Class 1, 2 and 3 Commodities in Open-Frame Rack Storage Arrangements	23
Table 8. Ceiling-Level Protection Guidelines for Class 4 and Cartoned Unexpanded Plastic Commodities in Open-Frame Rack Storage Arrangements	24
Table 9. Ceiling-Level Protection Guidelines for Cartoned Expanded Plastic Commodities in Open-Frame Rack Storage Arrangements	25
Table 10. Ceiling-Level Protection Guidelines for Uncartoned Unexpanded Plastic Commodities in Open-Frame Rack Storage Arrangements	25

8-9 Storage of Class 1, 2, 3, 4 and Plastic Commodities

Table 11. Ceiling-Level Protection Guidelines for Uncartoned Expanded Plastic Commodities in Open-Frame Rack Storage Arrangements	26
Table 12. Hydraulic Design for In-Rack Sprinkler Systems	45
Table 13. Determining Applicable Protection Table and Ceiling Height for Ceiling Sprinkler Designs when Ceiling-Level Sprinkler Systems are Supplemented with In-Rack Sprinklers	46
Table 14. Hose Demand and Water Supply Duration Design Guidelines	51
Table 14a. Ceiling-Level Sprinkler System Designs for Class 1 and 2 Commodities Protected by Dry-Pipe and Similar Sprinkler Systems	52
Table 14b. Ceiling-Level Sprinkler System Designs for Class 3 Commodities Protected by Dry-Pipe and Similar Sprinkler Systems	53
Table 15. Number of Sprinklers in the In-Rack Design	59
Table 16. Minimum Flow in the In-Rack Design	59
Table 17. Number of Face In-Rack Sprinklers in the Retrofit In-Rack Design	63
Table 17a. Minimum Number of K25.2EC (K360EC) Pendent In-Rack Sprinklers Included in the In-Rack Sprinkler Design	65
Table 17b. Quick-Response, 160°F (70°C) Nominally Rated, Standard-Coverage Pendent Storage Sprinkler Ceiling-Only Designs for Ceiling Heights Over 40 ft (12.0 m)	67
Table 18. Relationship Between the Number of Sprinklers that Operate During a Storage Fire and Fire Control	68

1.0 SCOPE

This property loss prevention data sheet provides fire protection recommendations for the storage of Class 1, 2, 3, 4, and plastic commodities maintained in rack, solid-piled, palletized, shelf, or bin-box storage arrangements. Apply this data sheet when (1) Class 1, 2 or 3 commodities are stored higher than 10 ft (3.0 m), (2) Class 4 or plastic commodities are stored higher than 5 ft (1.5 m), or (3) storage of any height occupies an area, as defined by minimum 8 ft (2.4 m) wide aisles, greater than 200 ft² (20 m²). Use the applicable occupancy-specific data sheet (see Appendix A) when storage consists of commodity hazards other than Class 1, 2, 3, 4 or plastics.

See Data Sheet 8-1, *Commodity Classification*, for guidelines on how to classify individual commodities; see Section 2.2.2 for information on how to determine an overall commodity rating for a given storage area.

Refer to FM Global Data Sheet 2-0, *Installation Guidelines for Automatic Sprinklers*, for installation guidelines for the sprinklers listed in this data sheet, as well as their compatibility with the facility's construction features.

The recommendations in Data Sheet 8-9 are intended for the design of new automatic sprinkler systems, or existing systems that are to be modified. To evaluate existing automatic sprinkler systems, or to determine whether new protection options based on recently FM Approved products and/or fire testing are a viable option to help lower their risk of loss, clients of FM Global can contact their local FM Global servicing office.

The fire protection recommendations in this data sheet are based on the results of full-scale fire testing, loss experience, and/or engineering judgment. Not every storage arrangement or protection option has been tested, nor has every potential solution been identified. If FM Global data sheets exist that address the specific occupancy, refer to those data sheets for further guidance.

Refer to the applicable occupancy-specific data sheet (see Appendix A for definition) for loss prevention recommendations related to the following subjects, which are not covered in this data sheet:

- Special hazards, such as the storage of flammable gases, flammable liquids, and flammable solids (usually found in 7-series data sheets)
- Commodities such as rubber tires, baled fiber, hanging garments, roll paper, baled waste paper, rolled non-woven fabrics, pallets, and carpets (usually found in 8-series data sheets)
- Storage arrangements, such as carousel storage or automatic storage storage and retrieval systems, containing high-value equipment (usually found 8-series data sheets)

Before selecting one of the protection options in this data sheet for either a new building or a building being retrofitted with a new protection system, consider possible future changes in storage arrangements, available water supplies, and/or commodity hazards. Also consider the susceptibility of the occupancy to nonthermal damage. If ceiling-only protection options are available, consider protecting to the highest commodity hazard that the ceiling height and the available water supply will allow in order to provide as much flexibility as possible for future changes in occupancy or water supply.

Note that the metric (SI) equivalent values in this data sheet are not based on strict mathematical conversion, but on design-desired values.

1.1 Changes

October 2020. Interim revision. Significant changes to this edition of the data sheet include the following:

- A. Clarification was provided in Section 2.2.3.1.3 as to when longitudinal flue spaces are not required within double-row racks.
- B. The aisle width that defines the depth of a multiple-row rack not provided with longitudinal flue spaces was added to Section 2.2.3.1.5.
- C. Guidance regarding the maximum stored product overhang beyond a horizontal barrier was added to Sections 2.3.4.6.3 and 2.3.6.4 to be consistent with the guidance provided in Section 2.3.6.7.1(D).
- D. Tables 14a, 14b and 17b were updated to allow open-frame multiple-row racks, as defined in Sections 2.2.3.1.4 and 2.2.3.1.5, to be protected in accordance with their design options.

E. The ceiling sprinkler protection options offered in Section 2.3.6.5 for both quick-response K14.0 (K200) and K16.8 (K240) pendent sprinklers were clarified when they are being used to protect the storage of uncartoned unexpanded plastics.

F. The definition of open-frame multiple-row racks was updated in Appendix A to match the requirements indicated in Sections 2.2.3.1.4 and 2.2.3.1.5.

1.2 Superseded Information

This edition of Data Sheet 8-9 did not incorporate or supersede any new engineering bulletins subsequent to the previously released edition of Data Sheet 8-9.

1.3 How to Use This Data Sheet

As with any FM Global data sheet, a complete and comprehensive understanding of the information in this document can only be achieved by a thorough review of its content. To assist with the proper use of this data sheet, however, two flowcharts have been created. The first flowchart (Figure 1) represents the process for determining the proper design of an automatic sprinkler system that is intended to protect solid-piled, palletized, shelf, or bin-box storage arrangements. The second flowchart (Figure 2) represents the process for determining the proper design of an automatic sprinkler system that is intended to protect rack storage.

Use these two flowcharts in combination with the text of this data sheet to determine all possible protection options.

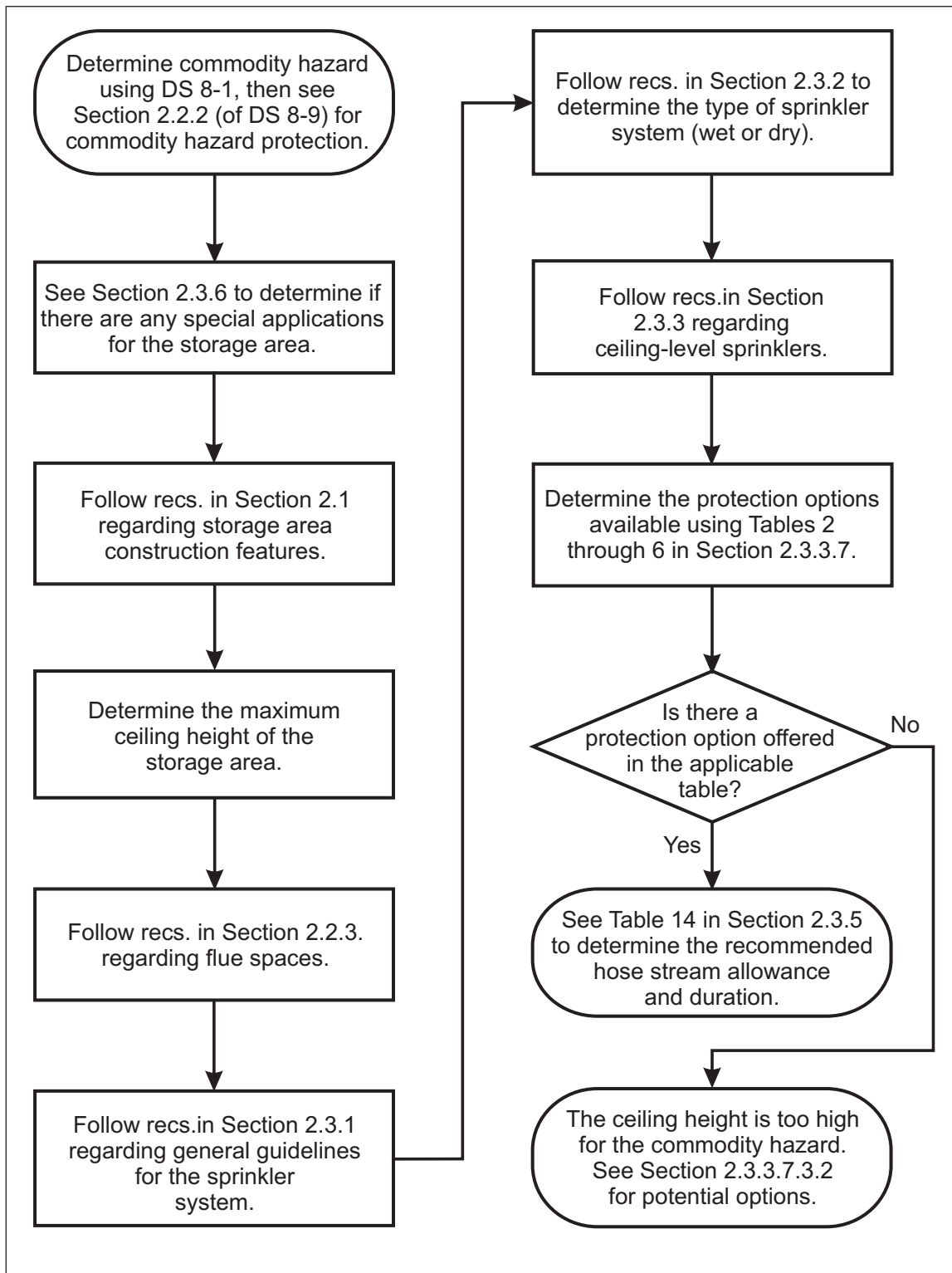

Fig. 1. Flowchart for determining the protection options for solid-piled, palletized, shelf, and bin-box storage arrangements

8-9 Storage of Class 1, 2, 3, 4 and Plastic Commodities

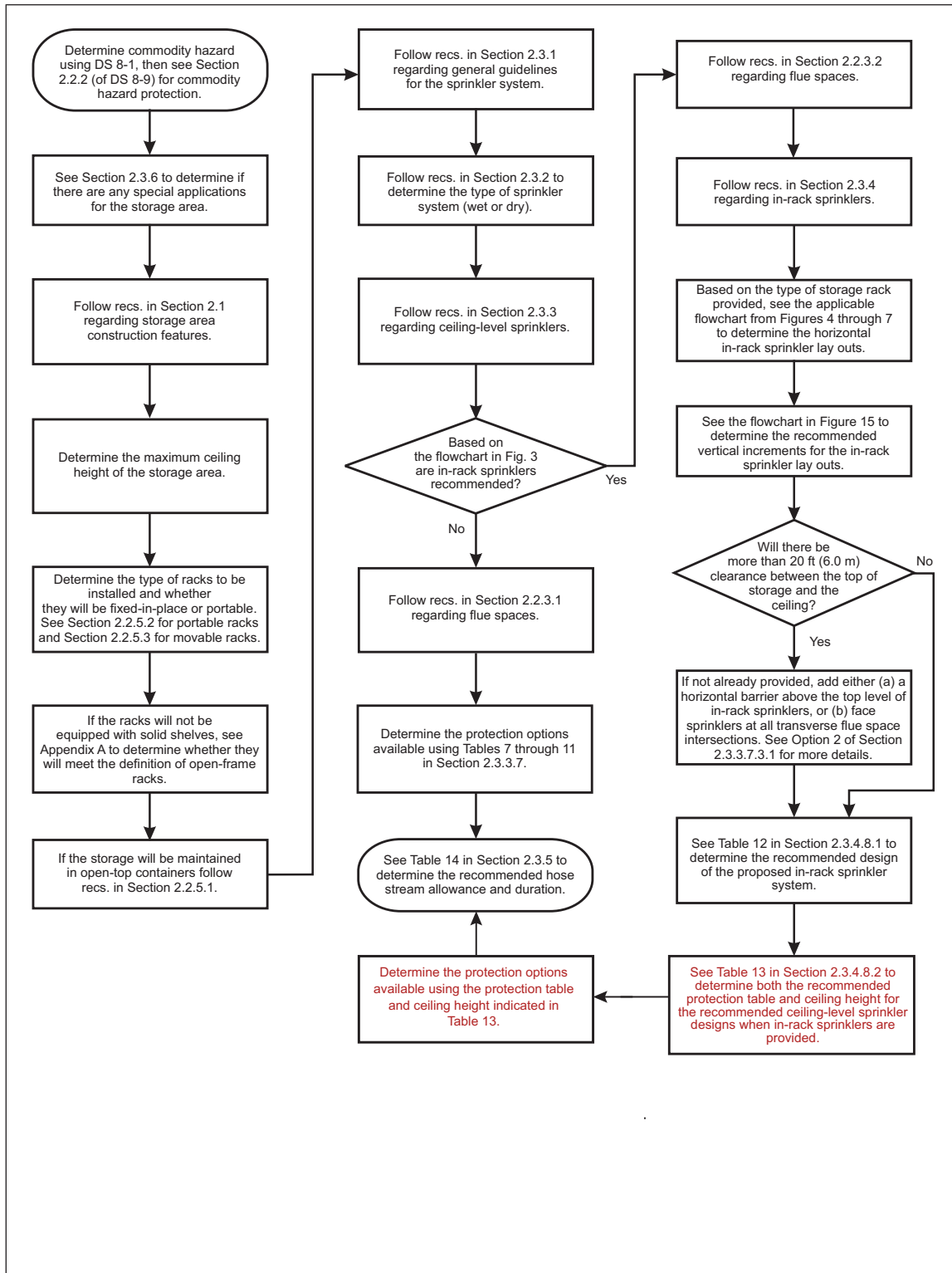

Fig. 2. Flowchart for determining the protection options available for rack storage arrangements

2.0 LOSS PREVENTION RECOMMENDATIONS

2.1 Construction and Location

2.1.1 General

2.1.1.1 Construct storage facilities in accordance with the relevant FM Global property loss prevention data sheets. See the 1-series data sheets for guidelines relevant to the construction features of most storage facilities.

2.1.1.2 Adhere to the recommendations in the relevant data sheet to ensure the construction features of the facility are compatible with the Storage sprinkler being used.

2.1.1.3 Properly anchor all rack storage structures to prevent them from falling over and, in turn, causing nearby racks to fall over (i.e., creating a “domino” effect). Take into consideration the effects of rack loads, the additional load created by the collection or absorption of fire protection water by the stored commodity, the weight of water-filled, in-rack sprinkler piping (if provided), and any seismic conditions (see Data Sheet 1-2, *Earthquakes*).

2.1.1.4 Design rack-supported structures taking into consideration the effects of weather (wind, snow, rain, hail, etc.), rack loads, seismic conditions (see Data Sheet 1-2, *Earthquakes*), and the additional load created by the collection or absorption of fire protection water by the stored commodity, the weight of water-filled sprinkler piping (from ceiling or in-rack sprinklers), and any other loads to which the rack or structure may be exposed. Account for additional weight created by the absorption of sprinkler water by corrugated containers. Assume a value of 0.012 lb (5.44 g) per 1 ft³ (0.028 m³) and apply this value to the overall volume of the pallet load. If open-top containers are present, assume roughly one-third of the containers stored vertically will be filled with water, but the other two-thirds of containers will be completely consumed during a fire event.

2.1.2 Steel Column Protection

Adhering to the design guidelines in this data sheet eliminates the need for both building column and overhead steel protection.

2.1.3 Heat and Smoke Venting and Draft Curtains

2.1.3.1 Heat and Smoke Venting

See Data Sheet 2-0, *Installation Guidelines for Automatic Sprinklers*, for recommendations related to the use of heat and smoke venting in the presence of Storage sprinklers.

2.1.3.2 Draft Curtains

See Data Sheet 2-0, *Installation Guidelines for Automatic Sprinklers*, for recommendations related to the use of draft curtains in the presence of Storage sprinklers.

2.2 Occupancy

2.2.1 General

Storage arrangements vary among locations. In general, most storage arrangements can be classified as solid-piled, palletized, shelf, bin-box, or single-row, double-row, or multiple-row racks for the purpose of determining fire protection requirements. Within this data sheet the design guidelines for solid-piled, palletized, shelf, or bin-box storage arrangements are consolidated into the same table for a given commodity hazard. Similarly, the design guidelines for single-row, double-row, and multiple-row storage racks are consolidated into the same table for a given commodity hazard.

2.2.1.1 For storage that will be maintained directly on the floor, refer to Data Sheet 1-24, *Protection Against Liquid Damage*, to minimize the exposure from sprinkler water discharge or other potential liquid releases.

2.2.2 Commodity Hazard

2.2.2.1 Use Data Sheet 8-1, *Commodity Classification*, to determine the types of commodity hazards located within a given storage area.

2.2.2.2 Base the protection for the storage area on the most severe commodity hazard present anywhere within that storage area. The commodity hazards for this data sheet are generally ranked from lowest hazard (Class 1) to highest hazard (uncartoned expanded plastic) as follows:

- Class 1
- Class 2
- Class 3
- Class 4
- Cartoned Unexpanded Plastic
- Cartoned Expanded Plastic
- Uncartoned Unexpanded Plastic
- Uncartoned Expanded Plastic

The ranking above applies for rack storage because the stability of storage that is provided by the rack structure. The ranking outlined above may be somewhat different when maintained in a solid-piled or palletized arrangement as storage instability can impact the protection required.

2.2.2.3 See Section 2.3.4.9 regarding Scheme 8-9A if the most severe commodity hazard exists in relatively small amounts throughout the storage area and protecting it creates a challenge.

2.2.3 Flue Spaces

Flue spaces within storage configurations that are arranged as outlined in this data sheet will promptly vent heat from a fire vertically. This allows for (1) the sprinklers to operate as quickly as possible, and (2) reduced horizontal fire spread within the storage array. Flue spaces arranged as outlined in this data sheet will also allow sprinkler water penetration down through the storage arrangement. Without sufficient water penetration to burning commodities throughout the storage array, fire control may not be achieved.

2.2.3.1 Flue Spaces for Rack Storage Protected by Ceiling-Level Sprinklers Only

2.2.3.1.1 In single-row racks, maintain all transverse flue spaces at a minimum net width of 3 in. (75 mm) throughout the vertical height of the rack. Provide transverse flue spaces a maximum of every 4-1/2 ft (1.4 m) horizontally when their net width is less than 6 in. (150 mm) or when their vertical alignment cannot be maintained. The maximum horizontal distance between well-maintained, vertically aligned transverse flue spaces can be increased to 9 ft (2.7 m) when their net width is 6 in. (150 mm) or greater.

2.2.3.1.2 In double-row racks, maintain all transverse flue spaces at a minimum net width of 3 in. (75 mm) throughout the vertical height of the rack. Provide transverse flue spaces a maximum of every 4-1/2 ft (1.4 m) horizontally when their net width is less than 6 in. (150 mm) or when their vertical alignment cannot be maintained. The maximum horizontal distance between well-maintained, vertically aligned transverse flue spaces can be increased to 9 ft (2.7 m) when their net width is 6 in. (150 mm) or greater and a minimum 6 in. (150 mm) wide vertically aligned longitudinal flue space is provided.

2.2.3.1.3 Longitudinal flue spaces are not required in double-row racks **when vertically aligned minimum 6 in. (150 mm) wide transverse flue spaces are provided a maximum of every 4-1/2 ft (1.4 m) horizontally.** However, if they are provided, maintain a minimum net width of 3 in. (75 mm) throughout the vertical height of the rack.

2.2.3.1.4 In multiple-row racks, maintain minimum 6 in. (150 mm) wide vertically aligned **longitudinal and transverse** flue spaces a maximum of every 5 ft (1.5 m) throughout the height of the rack.

2.2.3.1.5 For multiple-row racks not in accordance with Section 2.2.3.1.4:

- a) Provide minimum 6 in. (150 mm) wide transverse flue spaces a maximum of every 5 ft (1.5 m) horizontally, and
- b) Limit the depth of the multiple-row rack, **as defined by minimum 8 ft (2.4 m) wide aisles**, to 20 ft (6.0 m)

2.2.3.1.6 Arrange rolled or similar types of commodities stored in racks so they cannot bulge into or encroach over flue spaces. If adequate flue spaces are difficult to maintain (e.g., loading of racks becomes haphazard during peak production), provide wire mesh and/or other physical means to ensure adequate flue spaces are always maintained.

2.2.3.1.7 Treat storage racks not having flue spaces as described in Sections 2.2.3.1.1 through 2.2.3.1.6 as racks with solid shelves. Base the size of the shelf area on the presence of well-maintained, vertically aligned flue spaces having a minimum net width of 6 in. (150 mm). If well-maintained, vertically aligned flue spaces having a minimum net width of 6 in. (150 mm) cannot be provided, protect the racks based on the presence of solid shelves greater than 64 ft² (6.0 m²) in area.

2.2.3.2 Flue Spaces for Rack Storage Protected by both Ceiling-Level and In-Rack Sprinklers

2.2.3.2.1 In single-row racks, maintain all transverse flue spaces at a minimum net width of 3 in. (75 mm) throughout the vertical height of the rack. However, transverse flue spaces are not required (1) for the storage tier located directly above in-rack sprinklers, or (2) when in-rack sprinklers are provided at every tier level.

2.2.3.2.2 In double-row racks, maintain all transverse flue spaces at a minimum net width of 3 in. (75 mm) throughout the vertical height of the rack. Provide transverse flue spaces a maximum of every 4-1/2 ft (1.4 m) horizontally when their net width is less than 6 in. (150 mm) or when their vertical alignment cannot be maintained. The maximum horizontal distance between well-maintained, vertically aligned transverse flue spaces can be increased to 9 ft (2.7 m) when their net width is 6 in. (150 mm) or greater and a minimum 6 in. (150 mm) wide vertically aligned longitudinal flue space is provided. However, transverse flue spaces are not required (1) for the storage tier located directly above in-rack sprinklers, or (2) when in-rack sprinklers are provided at every tier level.

2.2.3.2.3 Longitudinal flue spaces are not required in double-row racks; however, if they are provided, maintain a minimum net width of 3 in. (75 mm) throughout the vertical height of the rack. Longitudinal flue spaces are not required (1) for the storage tier located directly above in-rack sprinklers, or (2) when in-rack sprinklers are provided at every tier level.

2.2.3.2.4 In multiple-row racks, maintain minimum 6 in. (150 mm) wide vertically aligned transverse flue spaces a maximum of every 5 ft (1.5 m) throughout the height of the rack. However, transverse flue spaces are not required (1) for the storage tier located directly above in-rack sprinklers, or (2) when in-rack sprinklers are provided at every tier level.

2.2.3.2.5 Arrange rolled or similar types of commodities stored in racks so they cannot bulge into or encroach over flue spaces located below in-rack sprinklers. The exception to this is storage located above a level of in-rack sprinklers. If adequate flue spaces are difficult to maintain (e.g., loading of racks becomes haphazard during peak production), provide wire mesh and/or other physical means to ensure adequate flue spaces are always maintained.

2.2.3.2.6 Treat storage racks not having flue spaces as described above in Sections 2.2.3.2.1 through 2.2.3.2.5 as racks with solid shelves greater than 64 ft² (6.0 m²) in area.

2.2.4 Pallets

2.2.4.1 Use noncombustible or metal pallets whenever possible.

2.2.4.2 Include the combustibility of pallets in the overall commodity classification. Refer to Data Sheet 8-1, *Commodity Classification*, for a description of how this can be accomplished.

2.2.4.3 Protect the storage of idle pallets in accordance with the recommendations in Data Sheet 8-24, *Idle Pallet Storage*.

2.2.5 Special Storage Considerations

2.2.5.1 Open-Top Containers Maintained in Storage Racks

Open-top containers will collect sprinkler water, keeping it from running across the top of storage and down the flues. This will prevent water penetration to the fire in the lower levels where it is needed thus resulting in inadequate fire protection. Rack collapse may also occur if too much water is collected See Section 2.2.5.1.1 when open-top noncombustible containers are present within rack storage, or Section 2.2.5.1.2 when open-top combustible containers are present within rack storage.

2.2.5.1.1 Protect storage racks containing open-top noncombustible containers per Sections 2.2.5.1.3 or 2.2.5.1.4 unless one of the following exceptions is met:

- 1) All of the storage located below the open-top noncombustible containers is either noncombustible or in noncombustible containers.
- 2) All of the open-top noncombustible containers are located on the bottom tier of the storage rack.
- 3) The open-top containers are designed to vent water into the transverse flue space, or uniformly around the container, with minimal water collection (maximum ½ in. [13 mm]) within the container. This can typically be accomplished by providing a minimum 30 percent venting area along the perimeter of the container. For this option to apply, storage within the container cannot be water absorbent nor be capable of blocking water from discharging through the container's vented area.

2.2.5.1.2 Protect storage racks containing open-top combustible containers per Sections 2.2.5.1.3 or 2.2.5.1.4 unless one of the following exceptions is met:

- 1) All of the open-top combustible containers are located on the bottom tier of the storage rack. Note, if the open-top containers are a higher commodity hazard than the storage located in the tier levels above them, then this option is only applicable if the sprinkler protection is capable of adequately protecting these containers as if they were closed-top and stored throughout the entire height of the rack.
- 2) The open-top containers are designed to vent water into the transverse flue space, or uniformly around the container, with minimal water collection (maximum ½ in. [13 mm]) within the container. This can typically be accomplished by providing a minimum 30 percent venting area along the perimeter of the container. For this option to apply, storage within the container cannot be water absorbent nor be capable of blocking water from discharging through the container's vented area.

2.2.5.1.3 When the open-top container hazard is not addressed in accordance with Sections 2.2.5.1.1 or 2.2.5.1.2 and the storage racks are either open-frame or have solid shelves up to 64 ft² (6.0 m²) in area, provide sprinkler protection for the racks as though 20 to 64 ft² (2.0 to 6.0 m²) solid shelves are present. In addition, at least one level of in-rack sprinklers is needed for any storage in excess of 10 ft (3.0 m) high. Install in-rack sprinklers in accordance with Figure 11 for single-row racks, Figure 13 for double-row racks, or Figure 14 for multiple-row racks at the vertical tier heights where in-rack sprinklers are recommended per Section 2.3.4.7.

2.2.5.1.4 When the open-top container hazard is not addressed in accordance with Sections 2.2.5.1.1 or 2.2.5.1.2 and the storage racks have solid shelves greater than 64 ft² (6.0 m²) in area, protect the rack storage based on presence of solid shelves greater than 64 ft² (6.0 m²) in area and install in-rack sprinklers in accordance with Figure 11 for single-row racks, Figure 13 for double-row racks, or Figure 14 for multiple-row racks.

2.2.5.1.4.1 For double-row racks, the horizontal distance between face sprinklers can be increased to 10 ft (3.0 m) when (1) there is only a single transverse flue space between the face sprinklers, and (2) solid shelves greater than 64 ft² (6.0 m²) in area are at all tier levels, or all of the tier levels without solid shelves that are located below the tier level with solid shelves have transverse flue spaces that are vertically aligned.

2.2.5.1.4.2 For multiple-row racks, the horizontal in-rack sprinkler arrangement can be in accordance with Figure 10 when (1) there is only a single transverse flue space between in-rack sprinklers, and (2) solid shelves greater than 64 ft² (6.0 m²) in area are at all tier levels, or all of the tier levels without solid shelves that are located below the tier level with solid shelves have flue spaces that are vertically aligned.

2.2.5.2 Portable Racks

Portable racks are designed to be transported with fork-lift trucks. They are typically found to have wire mesh siding with solid bottoms; however, they can be arranged in various configurations of solid or non-solid sides and bottoms. Commodity stored in portable racks burn differently than cartoned commodities maintained in storage racks, as the initial fire within a portable rack does not involve a surface fire on the outside of a cardboard box, but rather the actual commodity stored inside the portable rack. This generally results in a more challenging fire when compared to fires in open-frame storage racks.

If the portable racks are not provided with proper flue spaces between them (or with another means of allowing heat from a fire to vent vertically while at the same time water from sprinklers to penetrate down through them), fire control will not be possible.

2.2.5.2.1 Portable racks with bottoms at least 70% open: Treat as open-frame rack storage as long as the storage within the portable rack (1) allows heat from a fire to vent vertically up through the portable rack, and (2) allows water to penetrate down through the portable rack, and (3) does not absorb water. Otherwise, treat the portable rack as having a solid bottom.

2.2.5.2.2 Portable racks with solid bottoms or bottoms less than 70% open: Limit the footprint size of a portable rack to a maximum of 20 ft² (2.0 m²) and provide minimum 3 in. (75 mm) wide flue spaces around all sides of the portable rack. Protect such a portable rack arrangement in accordance with the guidelines for open-frame rack storage as outlined in Section 2.3.3.7. As an alternative, limit the footprint size of a portable rack to a maximum of 40 ft² (4.0 m²) and equip the portable rack with three full-height, fixed-in-place, solid wooden or noncombustible sides that will inhibit horizontal fire spread. Protect such a portable rack arrangement in accordance with the guidelines for solid-piled storage as outlined in Section 2.3.3.7.

2.2.5.2.3 Treat portable racks that do not meet the guidelines in Sections 2.2.5.2.1 or 2.2.5.2.2 as rack storage having solid shelves. Size the shelf area using the guidelines for rack storage.

2.2.5.2.4 If ceiling-only protection options are not available from the applicable protection table, then limit the storage area of the portable racks to a maximum of 100 ft² (9.3 m²), as defined by a minimum 8 ft (2.4 m) wide clear space on all sides of the storage area, and limit the storage height to a maximum of 10 ft (3.0 m) for cartoned commodities or 5 ft (1.5 m) if the commodity hazard is uncartoned plastics. Base the automatic sprinkler system design requirements on the occupancy surrounding the portable storage instead of the portable storage itself.

2.2.5.3 Movable Racks

Movable racks are designed to use as much of the available storage space as possible. Usually, racks are on tracks and are butted against one another in the aisle-face direction. Loading and unloading takes place in the aisle that is open. Loaded racks are located on one or both sides of the aisles, and empty racks may be located anywhere.

2.2.5.3.1 Protect rack storage in movable racks as multiple-row rack storage. Supply in-rack sprinklers (when required) via flexible in-rack sprinkler system connections, or other arrangements that provide sufficient water to the in-rack sprinklers.

2.2.6 Clearance Between Top of Storage and Ceiling-Level Sprinkler Deflector

Maintain a minimum 3 ft (0.9 m) clearance between the top of the storage and the ceiling-level sprinkler deflectors.

2.3 Protection

2.3.1 General

2.3.1.1 When determining the fire protection options for a storage facility, consider all the protection options the water supply can support. This approach will help maximize operational flexibility when considering potential future commodity changes and/or storage arrangements.

2.3.1.2 Regardless of the sprinkler system protection option chosen, it is imperative to coordinate a facility's construction, occupancy, and protection details in the planning stages so they are all compatible. It is critical that no objects between the top of storage and the ceiling-level sprinklers interfere with the sprinkler's proper discharge pattern. See Data Sheet 2-0, *Installation Guidelines for Automatic Sprinklers*, for guidelines related to obstructions of Storage sprinklers.

2.3.1.3 In addition to the recommendations in this data sheet, follow the sprinkler installation guidelines indicated for Storage sprinklers in Data Sheet 2-0, *Installation Guidelines for Automatic Sprinklers*.

2.3.1.4 Also, for facilities located in earthquake-prone regions, refer to FM Global Data Sheet 2-8, *Earthquake Protection for Water-Based Fire Protection Systems*.

2.3.2 Sprinkler System Types

Depending on the ambient temperature of the area being protected, sprinkler systems can be wet-pipe, dry-pipe, antifreeze solution, preaction, deluge, or refrigerated area. Note, however, that grid-type piping configurations are only recommended for wet-pipe and antifreeze solution sprinkler systems.

2.3.2.1 See Data Sheet 2-0, *Installation Guidelines for Automatic Sprinklers*, for additional guidelines related to the installation rules for all sprinkler system types; see Data Sheet 8-29, *Refrigerated Storage*, for additional guidelines related to the installation rules for refrigerated area sprinkler systems.

2.3.2.2 See Data Sheet 5-48, *Automatic Fire Detection*, for guidelines related to the installation of detection devices for pre-action and deluge type sprinkler systems.

2.3.2.3 Unless indicated otherwise in this data sheet, base water demands for antifreeze solution sprinkler systems on wet-pipe systems.

2.3.2.4 Base water demands for single-interlocked preaction sprinkler systems on either wet-pipe or dry-pipe systems, depending on the spacing of the heat detection devices located at the ceiling. See Data Sheet 5-48, *Automatic Fire Detection*, to determine the system type based on detector spacing. Base the design for all other preaction sprinkler system types on the designs indicated for dry-pipe systems.

2.3.2.5 Unless indicated otherwise in this data sheet, the maximum water delivery time for all dry-pipe and similar sprinkler systems is 40 seconds. For unobstructed ceiling construction, this maximum water delivery time is based on the operation of the most remote 4 sprinklers (2 sprinklers on 2 lines); for obstructed ceiling construction, it is based on the most remote 2 sprinklers (2 sprinklers on 1 line). For cut-off areas protected by a single sprinkler, the maximum water delivery time is 60 seconds.

2.3.3 Ceiling-Level Storage Sprinklers

2.3.3.1 General

FM Approved sprinklers for storage occupancy hazards and other similar high heat-release type fires are listed in the *Approval Guide*, an online resource of FM Approvals, under the heading of Storage Sprinklers (Ceiling-Level) or Storage Sprinklers (In-Racks). This section will discuss recommendations for FM Approved ceiling-level Storage sprinklers.

2.3.3.1.1 See Section 2.3.3.7 for the protection design guidelines of ceiling-level Storage sprinklers. Tables 2 through 6 provide design guidelines for solid-piled, palletized, shelf, and bin-box storage arrangements. The design guidelines for open-frame rack storage arrangements are provided in Tables 7 through 11. See Section 2.3.4.2.2 or 2.3.4.2.3 if storage racks have, or must be protected as if they have, solid shelves.

2.3.3.1.2 In addition to the guidelines outlined in Section 2.3.3.1.1, see Section 2.3.6 for any special applications that might be applicable for the commodity hazard and storage arrangement to be protected.

2.3.3.1.3 Follow the guidelines in Data Sheet 2-0, *Installation Guidelines for Automatic Sprinklers*, for the installation of ceiling-level Storage sprinklers.

2.3.3.2 K-Factors, Nominal Temperature Rating, RTI Rating, and the Orientation of Ceiling-Level Storage Sprinklers

2.3.3.2.1 Use only FM Approved sprinklers listed in the *Approval Guide* under the heading of Storage Sprinklers (Ceiling-Level) for any ceiling-level sprinkler options in this data sheet.

Currently, FM Approved ceiling-level Storage sprinklers have K-factor values ranging from 11.2 (160) to 33.6 (480). See Appendix A for a definition of K-factor as well as the units used for its indicated value.

Note that the following sprinklers are not FM Approved as ceiling-level Storage sprinklers:

- K8.0 (K115) and smaller
- On-Off type sprinklers
- ECLH type sprinklers
- ECOH type sprinklers

2.3.3.2.2 Unless indicated otherwise in this data sheet, use 160°F (70°C) nominal temperature rated, ceiling-level sprinklers in sprinkler systems that can be treated as wet-pipe. Use 212°F (100°C) nominal temperature rated ceiling-level sprinklers when the ambient temperature will exceed 100°F (38°C). When 212°F (100°C) rated sprinklers are required due to ambient temperature conditions, treat their presence the same as 160°F (70°C) rated sprinklers for design purposes. See Appendix A for a definition of nominal temperature rating as well as the temperature ranges each nominal value represents.

2.3.3.2.3 Unless indicated otherwise in this data sheet, use 280°F (140°C) nominal temperature rated ceiling-level sprinklers in dry-pipe, refrigerated area, or equivalent type systems.

2.3.3.2.4 Use ceiling-level sprinklers equipped with a quick-response thermal sensing element only in wet-pipe and antifreeze solution sprinkler systems unless recommended otherwise for specific applications in this data sheet.

2.3.3.2.5 Ceiling-level sprinklers equipped with standard-response thermal sensing elements can be used for wet-pipe, dry-pipe, antifreeze solution, preaction, and refrigerated area sprinkler systems unless indicated otherwise in this data sheet.

2.3.3.2.6 Use pendent ceiling-level sprinklers in wet-pipe or antifreeze solution systems only. Upright ceiling-level sprinklers can be used for wet-pipe, dry-pipe, antifreeze solution, preaction, and refrigerated area systems unless indicated otherwise in this data sheet.

2.3.3.2.7 Use dry-pendent ceiling-level sprinklers in wet-pipe or anti-freeze solution systems only. Design and installation requirements for dry-pendent sprinklers are based on those for a wet system using ceiling-level sprinklers having the same K-factor, RTI rating, sprinkler spacing coverage and temperature rating as the dry-pendent sprinkler.

2.3.3.3 Spacing of Ceiling-Level Storage Sprinklers

2.3.3.3.1 Install ceiling-level Storage sprinklers under unobstructed ceiling construction in accordance with the linear and area spacing guidelines in Table 1, unless indicated otherwise in this data sheet. See Data Sheet 2-0, *Installation Guidelines for Automatic Sprinklers*, for ceiling-level sprinkler spacing guidelines under obstructed ceiling construction.

Table 1. Spacing of Ceiling-Level Storage Sprinklers Under Unobstructed Ceiling Construction

Ceiling Height, ft (m)	Sprinkler K-Factor	Sprinkler Orientation	Sprinkler Response	Sprinkler Linear Spacing, ft (m)		Sprinkler Area Spacing, ft ² (m ²)	
				Min.	Max.	Min.	Max.
Up to 30 (9.0)	11.2 (160)	Pendent or Upright	Quick or Standard	8 (2.4)	12 (3.6)	80 (7.5)	100 (9.0)
	14.0 (200), 16.8 (240), 19.6 (280), 22.4 (320), 25.2 (360), 28.0 (400), 33.6 (480)	Pendent	Quick or Standard	8 (2.4)	12 (3.6)	64 (6.0)	100 (9.0)
		Upright	Quick	8 (2.4)	12 (3.6)	64 (6.0)	100 (9.0)
			Standard	8 (2.4)	12 (3.6)	80 (7.5)	100 (9.0)
		25.2EC (360EC)	Pendent or Upright	Quick	10 (3.0)	14 (4.2)	100 (9.0)
Over 30 (9.0)	11.2 (160)	Pendent or Upright	Quick or Standard	8 (2.4)	10 (3.0)	80 (7.5)	100 (9.0)
	14.0 (200), 16.8 (240), 19.6 (280), 22.4 (320), 25.2 (360), 28.0 (400), 33.6 (480)	Pendent or Upright	Quick	8 (2.4)	10 (3.0)	64 (6.0)	100 (9.0)
			Standard	8 (2.4)	10 (3.0)	80 (7.5)	100 (9.0)
	25.2EC (360EC)	Pendent or Upright	Quick	10 (3.0)	14 (4.2)	100 (9.0)	196 (18.0)

2.3.3.4 Minimum Recommended Pressures for Ceiling-Level Storage Sprinklers

The sprinkler system designs in this data sheet for ceiling-level sprinklers are based on an indicated minimum operating pressure for a given sprinkler K-factor. As a result, base the minimum required ceiling-level sprinkler pressure on the value indicated in the applicable protection table for the commodity hazard, storage arrangement, and ceiling height involved.

2.3.3.5 Extension of Hydraulic Design

Extend the hydraulic design for storage occupancies at least one branchline or sprinkler beyond all edges of the storage, or to a wall, whenever there is mixed-use occupancy. Whenever two adjacent storage occupancies are protected differently, extend the design for the higher hazard one branchline or sprinkler into the lower hazard area.

2.3.3.6 Mixing Different Ceiling-Level Storage Sprinklers Within the Same Protected Area

2.3.3.6.1 For a sprinkler system protecting a storage occupancy, install ceiling-level Storage sprinklers having the same K-factor, orientation, response time index (RTI) rating, and temperature rating throughout the sprinkler system, whenever possible.

2.3.3.6.2 Do not mix different types of sprinklers (e.g., Storage and Non-Storage sprinklers) on the same ceiling-level sprinkler system within the same protected area unless indicated otherwise by this data sheet.

2.3.3.6.3 Do not mix sprinklers having different K-factors on the same ceiling-level sprinkler system within the same protected area unless indicated otherwise by this data sheet.

2.3.3.6.4 Do not mix sprinklers having different orientations (i.e., pendent and upright) on the same ceiling-level sprinkler system within the same protected area unless indicated otherwise by this data sheet. See Data Sheet 2-0, *Installation Guidelines for Automatic Sprinklers*, for recommendations regarding the mixing of pendent and upright sprinklers on the same ceiling-level sprinkler system for the purpose of eliminating obstruction to sprinkler discharge.

2.3.3.6.5 Do not mix sprinklers having different response time index (RTI) ratings (i.e., quick-response and standard-response) on the same ceiling-level sprinkler system within the same protected area unless a clear delineation between the area protected by quick-response sprinklers and the area protected by standard-response sprinklers can be provided. When mixing quick-response and standard-response sprinklers at ceiling-level cannot be avoided, a draft curtain is needed:

- When the roofs over the two areas are at the same elevation, or
- When the quick-response ceiling-level sprinklers are at a higher elevation than the standard-response ceiling-level sprinklers

See the guidelines in Data Sheet 1-10, *Smoke and Heat Venting in One-story Sprinklered Buildings*, regarding the installation guidelines of a draft curtain and the minimum clear space recommended below it.

2.3.3.6.6 Do not mix sprinklers having different nominal temperature ratings (i.e., 160°F [70°C] and 280°F [140°C]) on the same ceiling-level sprinkler system within the same protected area unless indicated otherwise within this data sheet. Note that mixing sprinklers having different nominal temperature ratings on the same ceiling-level sprinkler system is acceptable when ambient conditions, such as the immediate area around unit heaters, require a higher temperature-rated sprinkler to avoid the potential for premature operation.

2.3.3.7 Ceiling-Level Sprinkler System Design Criteria

2.3.3.7.1 General

The ceiling-level protection options in this data sheet are provided in Tables 2 through 11 as follows:

- Table 2. Ceiling-Level Protection Guidelines for Class 1, 2 and 3 Commodities in a Solid-Piled, Palletized, Shelf, or Bin-Box Storage Arrangement
- Table 3. Ceiling-Level Protection Guidelines for Class 4 and Cartoned Unexpanded Plastic Commodities in a Solid-Piled, Palletized, Shelf, or Bin-Box Storage Arrangement
- Table 4: Ceiling-Level Protection Guidelines for Cartoned Expanded Plastic Commodities in a Solid-Piled, Palletized, Shelf, or Bin-Box Storage Arrangement

- Table 5: Ceiling-Level Protection Guidelines for Uncartoned Unexpanded Plastic Commodities in a Solid-Piled, Palletized, Shelf, or Bin-Box Storage Arrangement
- Table 6: Ceiling-Level Protection Guidelines for Uncartoned Expanded Plastic Commodities in a Solid-Piled, Palletized, Shelf, or Bin-Box Storage Arrangement
- Table 7: Ceiling-Level Protection Guidelines for Class 1, 2 and 3 Commodities in Open-Frame Rack Storage Arrangements
- Table 8: Ceiling-Level Protection Guidelines for Class 4 and Cartoned Unexpanded Plastic Commodities in Open-Frame Rack Storage Arrangements
- Table 9: Ceiling-Level Protection Guidelines for Cartoned Expanded Plastic Commodities in Open-Frame Rack Storage Arrangements
- Table 10: Ceiling-Level Protection Guidelines for Uncartoned Unexpanded Plastic Commodities in Open-Frame Rack Storage Arrangements
- Table 11: Ceiling-Level Protection Guidelines for Uncartoned Expanded Plastic Commodities in Open-Frame Rack Storage Arrangements

The ceiling-level designs listed within these tables are provided to either (1) achieve suppression like performance, or (2) when suppression like performance is not available offer the lowest allowable pressure for design purposes. If a design listed for a higher ceiling height hydraulically offers a better option than for the design indicated for the ceiling height of the storage area, the design for the higher ceiling height can be utilized.

In each table, the ceiling-level protection options highlighted in green represent those for which the hose stream demand is 250 gpm (950 L/min) and the duration is 1 hour. These highlighted options have the potential result in less fire, smoke, and water damage than other acceptable options and thus may, from a sustainability standpoint, be preferable.

See Section 2.3.2.5 regarding the water delivery time requirements for the protection options offered in Tables 2 through 11 for dry-pipe type systems.

The design guidelines for ceiling-level Storage sprinklers are based on five main attributes assigned to a sprinkler. They are:

- K-Factor (orifice size)
- Orientation (pendent or upright)
- Response time index rating (quick-response or standard-response)
- Nominal temperature rating
- Sprinkler spacing (standard or extended-coverage)

Once the commodity hazard, storage arrangement, and peak ceiling height for the protected area is known, the protection design options for the sprinkler system can be determined using the appropriate protection table in combination with the five sprinkler attributes.

2.3.3.7.1.1 See Section 2.3.4.2.2 or 2.3.4.2.3 for the protection options recommended for storage racks provided with solid shelves.

2.3.3.7.1.2 See Section 2.3.3.7.3.2 when ceiling heights exceed those indicated in Tables 2 through 6.

2.3.3.7.1.3 See Section 2.3.3.7.3.1 when ceiling heights exceed those indicated in Tables 7 through 11.

2.3.3.7.1.4 If a ceiling-only protection option is available and is chosen for installation, see Section 2.3.5 to determine the hose demand and the duration needed for the sprinkler system design.

2.3.3.7.1.5 If a combination ceiling and in-rack sprinkler system is chosen for installation, see Section 2.3.4.8 to determine the requirements for the combined in-rack and ceiling-level sprinkler system.

2.3.3.7.2 Ceiling-Level Design Guidelines

The ceiling-level protection design guidelines listed in the following tables use a design format based on an indicated number of operating sprinklers at a given minimum sprinkler operating pressure. Do not interpolate or make adjustments to the values listed in these tables.

2.3.3.7.2.1 To determine the protection options available, find the appropriate protection table based on commodity hazard and storage arrangement. If the storage arrangement is racks with solid shelves or racks that must be protected as if they have solid shelves, see Section 2.3.4.2.2 or 2.3.4.2.3 to determine the protection options available.

2.3.3.7.2.2 Once the appropriate table has been chosen, the available protection options can be determined based on the maximum ceiling height of the protected area and the type of sprinkler system (wet or dry) to be installed. The ceiling-level sprinkler system design can be based on any ceiling height from the protection table that is equal to or higher than the maximum ceiling height of the protected area.

2.3.3.7.2.3 The minimum design area (i.e. the number of sprinklers in the design multiplied by the spacing of the sprinklers) is 768 ft² (71 m²), except when sprinklers are required in every channel created by obstructed construction. When the design area is less than 768 ft² (71 m²) and sprinklers are not required in every channel, increase the number of sprinklers in the ceiling design, as needed, to meet this minimum design area. Note that the hose demand and water supply duration requirements from Table 14 are not based on the number of sprinklers required per this section, but rather are based on the number of sprinklers indicated in the design obtained from the applicable protection table.

2.3.3.7.2.4 The units for K-factor values given in Tables 2 through 11 are gpm/psi^{0.5} ([L/min]/bar^{0.5}).

2.3.3.7.2.5 For a given storage arrangement, commodity hazard and ceiling height, ceiling-level protection options for pendent sprinklers can also be based on those listed for upright sprinklers having the same K-factor, RTI rating, nominal temperature rating and linear/area spacing requirements.

Table 2. Ceiling-Level Protection Guidelines for Class 1, 2, and 3 Commodities in a Solid-Piled, Palletized, Shelf, or Bin-Box Storage Arrangement

Max. Ceiling Height, ft (m)	Wet System, 160°F (70°C) Nominally Rated, Pendent Sprinklers										Wet System, 160°F (70°C) Nominally Rated, Upright Sprinklers						Dry System, 280°F (140°C) Nominally Rated, Upright Sprinklers			
	Quick Response						Standard Response				Quick Response				Standard Response		Standard Response			
	K11.2 (K160)	K14.0 (K200)	K16.8 (K240)	K22.4 (K320)	K25.2 (K360)	K25.2EC (K360EC)	K11.2 (K160)	K14.0 (K200)	K19.6 (K280)	K25.2 (K360)	K11.2 (K160)	K14.0 (K200)	K16.8 (K240)	K25.2EC (K360EC)	K11.2 (K160)	K16.8 (K240)	K25.2 (K360)	K11.2 (K160)	K16.8 (K240)	K25.2 (K360)
10 (3.0)	12 @ 7 (0.5)	9 @ 7 (0.5)	9 @ 7 (0.5)	9 @ 20 (1.4)	9 @ 20 (1.4)	6 @ 20 (1.4)	12 @ 7 (0.5)	9 @ 7 (0.5)	9 @ 16 (1.1)	9 @ 7 (0.5)	12 @ 7 (0.5)	9 @ 7 (0.5)	9 @ 7 (0.5)	6 @ 20 (1.4)	12 @ 7 (0.5)	9 @ 7 (0.5)	9 @ 7 (0.5)	16 @ 7 (0.5)	16 @ 7 (0.5)	16 @ 7 (0.5)
20 (6.0)	12 @ 10 (0.7)	12 @ 7 (0.5)	12 @ 7 (0.5)	9 @ 20 (1.4)	9 @ 20 (1.4)	6 @ 20 (1.4)	12 @ 10 (0.7)	12 @ 7 (0.5)	9 @ 16 (1.1)	9 @ 7 (0.5)	12 @ 10 (0.7)	12 @ 7 (0.5)	12 @ 7 (0.5)	6 @ 20 (1.4)	12 @ 10 (0.7)	12 @ 7 (0.5)	9 @ 7 (0.5)	16 @ 10 (0.7)	16 @ 7 (0.5)	16 @ 7 (0.5)
25 (7.5)	10 @ 30 (2.1)	10 @ 20 (1.4)	10 @ 13 (0.9)	9 @ 20 (1.4)	9 @ 20 (1.4)	6 @ 20 (1.4)	10 @ 30 (2.1)	10 @ 20 (1.4)	9 @ 16 (1.1)	10 @ 7 (0.5)	10 @ 30 (2.1)	10 @ 20 (1.4)	10 @ 13 (0.9)	6 @ 20 (1.4)	10 @ 30 (2.1)	10 @ 13 (0.9)	10 @ 7 (0.5)	20 @ 16 (1.1)	20 @ 7 (0.5)	20 @ 7 (0.5)
30 (9.0)	18 @ 50 (3.5)	12 @ 50 (3.5)	12 @ 35 (2.4)	9 @ 20 (1.4)	9 @ 20 (1.4)	6 @ 25 (1.7)	18 @ 50 (3.5)	18 @ 32 (2.2)	9 @ 16 (1.1)	9 @ 10 (0.7)	18 @ 50 (3.5)	12 @ 50 (3.5)	12 @ 35 (2.4)	6 @ 25 (1.7)	18 @ 50 (3.5)	18 @ 22 (1.5)	12 @ 20 (1.4)	25 @ 50 (3.5)	25 @ 22 (1.5)	25 @ 10 (0.7)
35 (10.5)		9 @ 75 (5.2)	9 @ 52 (3.6)	9 @ 28 (1.9)	9 @ 22 (1.5)	6 @ 60 (4.1) ^a			15 @ 25 (1.7)	9 @ 30 (2.1)		9 @ 75 (5.2)	9 @ 52 (3.6)	8 @ 40 (2.8)				See Section 2.3.6.1		
40 (12.0)		9 @ 75 (5.2)	9 @ 52 (3.6)	9 @ 28 (1.9)	9 @ 22 (1.5)					9 @ 30 (2.1)										

^a An acceptable alternative design is 8 @ 40 (2.8) when a 12 ft (3.6 m) maximum linear spacing is used

Table 3. Ceiling-Level Protection Guidelines for Class 4 and Cartoned Unexpanded Plastic Commodities in a Solid-Piled, Palletized, Shelf, or Bin-Box Storage Arrangement

Protection of Class 4 and Cartoned Unexpanded Plastic Commodities in Solid-Piled, Palletized, Shelf, and Bin-Box Arrangements; No. of AS @ psi (bar)																					
Max. Ceiling Height, ft (m)	Wet System, 160°F (70°C) Nominally Rated, Pendent Sprinklers										Wet System, 160°F (70°C) Nominally Rated, Upright Sprinklers						Dry System, 280°F (140°C) Nominally Rated, Upright Sprinklers				
	Quick Response						Standard Response				Quick Response				Standard Response		Standard Response				
	K11.2 (K160)	K14.0 (K200)	K16.8 (K240)	K22.4 (K320)	K25.2 (K360)	K25.2EC (K360EC)	K11.2 (K160)	K14.0 (K200)	K19.6 (K280)	K25.2 (K360)	K11.2 (K160)	K14.0 (K200)	K16.8 (K240)	K25.2EC (K360EC)	K11.2 (K160)	K16.8 (K240)	K25.2 (K360)	K11.2 (K160)	K16.8 (K240)	K25.2 (K360)	
10 (3.0)	12 @ 7 (0.5)	9 @ 7 (0.5)	9 @ 7 (0.5)	9 @ 20 (1.4)	9 @ 20 (1.4)	6 @ 20 (1.4)	12 @ 7 (0.5)	9 @ 7 (0.5)	9 @ 16 (1.1)	9 @ 7 (0.5)	12 @ 7 (0.5)	9 @ 7 (0.5)	9 @ 7 (0.5)	6 @ 20 (1.4)	12 @ 7 (0.5)	9 @ 7 (0.5)	9 @ 7 (0.5)	16 @ 7 (0.5)	16 @ 7 (0.5)	16 @ 7 (0.5)	
15 (4.5)	12 @ 15 (1.0)	12 @ 10 (0.7)	12 @ 7 (0.5)	9 @ 20 (1.4)	9 @ 20 (1.4)	6 @ 20 (1.4)	12 @ 15 (1.0)	12 @ 10 (0.7)	9 @ 16 (1.1)	10 @ 7 (0.5)	12 @ 15 (1.0)	12 @ 10 (0.7)	12 @ 7 (0.5)	6 @ 20 (1.4)	12 @ 15 (1.0)	12 @ 7 (0.5)	10 @ 7 (0.5)	16 @ 20 (1.4)	16 @ 7 (0.5)	16 @ 7 (0.5)	
20 (6.0)	10 @ 30 (2.1)	10 @ 20 (1.4)	10 @ 13 (0.9)	9 @ 20 (1.4)	9 @ 20 (1.4)	6 @ 20 (1.4)	10 @ 30 (2.1)	10 @ 20 (1.4)	9 @ 16 (1.1)	10 @ 7 (0.5)	10 @ 30 (2.1)	10 @ 20 (1.4)	10 @ 13 (0.9)	6 @ 20 (1.4)	10 @ 30 (2.1)	10 @ 13 (0.9)	10 @ 7 (0.5)	16 @ 30 (2.1)	16 @ 13 (0.9)	16 @ 7 (0.5)	
25 (7.5)	10 @ 30 (2.1)	10 @ 20 (1.4)	10 @ 13 (0.9)	9 @ 20 (1.4)	9 @ 20 (1.4)	6 @ 20 (1.4)	10 @ 30 (2.1)	10 @ 20 (1.4)	9 @ 16 (1.1)	10 @ 7 (0.5)	10 @ 30 (2.1)	10 @ 20 (1.4)	10 @ 13 (0.9)	6 @ 20 (1.4)	10 @ 30 (2.1)	10 @ 13 (0.9)	10 @ 7 (0.5)	16 @ 30 (2.1)	16 @ 13 (0.9)	16 @ 7 (0.5)	
30 (9.0)	25 @ 50 (3.5)	12 @ 50 (3.5)	12 @ 35 (2.4)	9 @ 20 (1.4)	9 @ 20 (1.4)	6 @ 30 (2.1)	25 @ 50 (3.5)	25 @ 32 (2.2)	9 @ 16 (1.1)	9 @ 10 (0.7)	25 @ 50 (3.5)	12 @ 50 (3.5)	12 @ 35 (2.4)	6 @ 30 (2.1)	25 @ 50 (3.5)	25 @ 22 (1.5)	12 @ 20 (1.4)	30 @ 50 (3.5)	30 @ 22 (1.5)	30 @ 10 (0.7)	
35 (10.5)		9 @ 75 (5.2)	9 @ 52 (3.6)	9 @ 28 (1.9)	9 @ 22 (1.5)	6 @ 60 (4.1) ^a			15 @ 25 (1.7)	9 @ 30 (2.1)		12 @ 75 (5.2)	12 @ 52 (3.6)	8 @ 40 (2.8)							
40 (12.0)		9 @ 75 (5.2)	9 @ 52 (3.6)	9 @ 28 (1.9)	9 @ 22 (1.5)					9 @ 30 (2.1)											

^a An acceptable alternative design is 8 @ 40 (2.8) when a 12 ft (3.6 m) maximum linear spacing is used

Table 4. Ceiling-Level Protection Guidelines for Cartoned Expanded Plastic Commodities in a Solid-Piled, Palletized, Shelf, or Bin-Box Storage Arrangement

Max. Ceiling Height, ft (m)	Protection of Cartoned Expanded Plastic Commodities in Solid-Piled, Palletized, Shelf, and Bin-Box Arrangements; No. of AS @ psi (bar)																			
	Wet System, 160°F (70°C) Nominally Rated, Pendent Sprinklers						Wet System, 160°F (70°C) Nominally Rated, Upright Sprinklers						Dry System, 280°F (140°C) Nominally Rated, Upright Sprinklers							
	Quick Response			Standard Response			Quick Response			Standard Response			Standard Response							
	K11.2 (K160)	K14.0 (K200)	K16.8 (K240)	K22.4 (K320)	K25.2 (K360)	K25.2EC (K360EC)	K11.2 (K160)	K14.0 (K200)	K19.6 (K280)	K25.2 (K360)	K11.2 (K160)	K14.0 (K200)	K16.8 (K240)	K25.2EC (K360EC)	K11.2 (K160)	K16.8 (K240)	K25.2 (K360)	K11.2 (K160)	K16.8 (K240)	K25.2 (K360)
10 (3.0)	12 @ 10 (0.7)	12 @ 7 (0.5)	12 @ 7 (0.5)	9 @ 20 (1.4)	9 @ 20 (1.4)	6 @ 20 (1.4)	12 @ 10 (0.7)	12 @ 7 (0.5)	12 @ 16 (1.1)	12 @ 7 (0.5)	12 @ 10 (0.7)	12 @ 7 (0.5)	12 @ 7 (0.5)	6 @ 20 (1.4)	12 @ 10 (0.7)	12 @ 7 (0.5)	12 @ 7 (0.5)	16 @ 10 (0.7)	16 @ 7 (0.5)	16 @ 7 (0.5)
20 (6.0)	12 @ 40 (2.8)	12 @ 18 (1.2)	12 @ 13 (0.9)	9 @ 20 (1.4)	9 @ 20 (1.4)	6 @ 20 (1.4)	12 @ 40 (2.8)	12 @ 18 (1.2)	12 @ 16 (1.1)	12 @ 7 (0.5)	12 @ 40 (2.8)	12 @ 26 (1.8)	12 @ 18 (1.2)	6 @ 20 (1.4)	12 @ 40 (2.8)	12 @ 18 (1.2)	12 @ 8 (0.6)	16 @ 40 (2.8)	16 @ 18 (1.2)	16 @ 8 (0.6)
25 (7.5)	12 @ 50 (3.5)	9 @ 50 (3.5)	9 @ 35 (2.4)	9 @ 20 (1.4)	9 @ 20 (1.4)	6 @ 20 (1.4)	12 @ 50 (3.5)	12 @ 32 (2.2)	12 @ 16 (1.1)	12 @ 10 (0.7)	12 @ 50 (3.5)	12 @ 32 (2.2)	12 @ 22 (1.5)	6 @ 20 (1.4)	12 @ 50 (3.5)	12 @ 22 (1.5)	12 @ 10 (0.7)	20 @ 50 (3.5)	20 @ 22 (1.5)	20 @ 10 (0.7)
30 (9.0)	25 @ 50 (3.5)	12 @ 50 (3.5)	12 @ 35 (2.4)	12 @ 25 (1.7)	12 @ 20 (1.4)	12 @ 38 (2.6)	25 @ 50 (3.5)	25 @ 32 (2.2)	25 @ 20 (1.4)	25 @ 10 (0.7)	25 @ 50 (3.5)	12 @ 50 (3.5)	12 @ 35 (2.4)	12 @ 38 (2.6)	25 @ 50 (3.5)	25 @ 22 (1.5)	25 @ 10 (0.7)	30 @ 50 (3.5)	30 @ 22 (1.5)	30 @ 10 (0.7)
35 (10.5)				12 @ 63 (4.3)	12 @ 50 (3.5)															
40 (12.0)				12 @ 75 (5.2)	12 @ 60 (4.1)															

Table 5. Ceiling-Level Protection Guidelines for Uncartoned Unexpanded Plastic Commodities in a Solid-Piled, Palletized, Shelf, or Bin-Box Storage Arrangement

Protection of Uncartoned Unexpanded Plastic Commodities in Solid-Piled, Palletized, Shelf, and Bin-Box Arrangements; No. of AS @ psi (bar)																					
Max. Ceiling Height, ft (m)	Wet System, 160°F (70°C) Nominally Rated, Pendent Sprinklers										Wet System, 160°F (70°C) Nominally Rated, Upright Sprinklers						Dry System, 280°F (140°C) Nominally Rated, Upright Sprinklers				
	Quick Response					Standard Response					Quick Response				Standard Response		Standard Response				
	K11.2 (K160)	K14.0 (K200)	K16.8 (K240)	K22.4 (K320)	K25.2 (K360)	K25.2EC (K360EC)	K11.2 (K160)	K14.0 (K200)	K19.6 (K280)	K25.2 (K360)	K11.2 (K160)	K14.0 (K200)	K16.8 (K240)	K25.2EC (K360EC)	K11.2 (K160)	K16.8 (K240)	K25.2 (K360)	K11.2 (K160)	K16.8 (K240)	K25.2 (K360)	
10 (3.0)	12 @ 10 (0.7)	12 @ 7 (0.5)	12 @ 7 (0.5)	9 @ 20 (1.4)	9 @ 20 (1.4)	6 @ 20 (1.4)	12 @ 10 (0.7)	12 @ 7 (0.5)	12 @ 16 (1.1)	12 @ 7 (0.5)	12 @ 10 (0.7)	12 @ 7 (0.5)	12 @ 7 (0.5)	6 @ 20 (1.4)	12 @ 10 (0.7)	12 @ 7 (0.5)	12 @ 7 (0.5)	16 @ 10 (0.7)	16 @ 7 (0.5)	16 @ 7 (0.5)	
20 (6.0)	12 @ 40 (2.8)	12 @ 26 (1.8)	12 @ 18 (1.2)	9 @ 20 (1.4)	9 @ 20 (1.4)	6 @ 30 (2.1)	12 @ 40 (2.8)	12 @ 26 (1.8)	12 @ 16 (1.1)	12 @ 8 (0.6)	12 @ 40 (2.8)	12 @ 26 (1.8)	12 @ 18 (1.2)	6 @ 30 (2.1)	12 @ 40 (2.8)	12 @ 18 (1.2)	12 @ 8 (0.6)	16 @ 40 (2.8)	16 @ 18 (1.2)	16 @ 8 (0.6)	
25 (7.5)	12 @ 50 (3.5)	9 @ 50 (3.5)	9 @ 35 (2.4)	9 @ 20 (1.4)	9 @ 20 (1.4)	6 @ 38 (2.6)	12 @ 50 (3.5)	12 @ 32 (2.2)	12 @ 16 (1.1)	12 @ 10 (0.7)	12 @ 50 (3.5)	12 @ 32 (2.2)	12 @ 22 (1.5)	6 @ 38 (2.6)	12 @ 50 (3.5)	12 @ 22 (1.5)	12 @ 10 (0.7)	20 @ 50 (3.5)	20 @ 22 (1.5)	20 @ 10 (0.7)	
30 (9.0)	25 @ 50 (3.5)	9 @ 100 (6.9)	9 @ 70 (4.8)	9 @ 50 (3.5)	9 @ 40 (2.8)	12 @ 38 (2.6)	25 @ 50 (3.5)	25 @ 32 (2.2)	25 @ 16 (1.1)	25 @ 10 (0.7)	25 @ 50 (3.5)	25 @ 32 (2.2)	25 @ 22 (1.5)	12 @ 38 (2.6)	25 @ 50 (3.5)	25 @ 22 (1.5)	25 @ 10 (0.7)	30 @ 50 (3.5)	30 @ 22 (1.5)	30 @ 10 (0.7)	
35 (10.5)				12 @ 63 (4.3)	12 @ 50 (3.5)																
40 (12.0)				12 @ 75 (5.2)	12 @ 60 (4.1)																

Table 6. Ceiling-Level Protection Guidelines for Uncartoned Expanded Plastic Commodities in a Solid-Piled, Palletized, Shelf or Bin-Box Storage Arrangement

Protection of Uncartoned Expanded Plastic Commodities in Solid-Piled, Palletized, Shelf and Bin-Box Arrangements; No. of AS @ psi (bar)																					
Max. Ceiling Height, ft (m)	Wet System, 160°F (70°C) Nominally Rated, Pendent Sprinklers										Wet System, 160°F (70°C) Nominally Rated, Upright Sprinklers						Dry System, 280°F (140°C) Nominally Rated, Upright Sprinklers				
	Quick Response					Standard Response					Quick Response				Standard Response		Standard Response				
	K11.2 (K160)	K14.0 (K200)	K16.8 (K240)	K22.4 (K320)	K25.2 (K360)	K25.2EC (K360EC)	K11.2 (K160)	K14.0 (K200)	K19.6 (K280)	K25.2 (K360)	K11.2 (K160)	K14.0 (K200)	K16.8 (K240)	K25.2EC (K360EC)	K11.2 (K160)	K16.8 (K240)	K25.2 (K360)	K11.2 (K160)	K16.8 (K240)	K25.2 (K360)	
10 (3.0)	12 @ 10 (0.7)	12 @ 7 (0.5)	12 @ 7 (0.5)	9 @ 20 (1.4)	9 @ 20 (1.4)	6 @ 20 (1.4)	12 @ 10 (0.7)	12 @ 7 (0.5)	12 @ 16 (1.1)	12 @ 7 (0.5)	12 @ 10 (0.7)	12 @ 7 (0.5)	12 @ 7 (0.5)	6 @ 20 (1.4)	12 @ 10 (0.7)	12 @ 7 (0.5)	12 @ 7 (0.5)	20 @ 10 (0.7)	20 @ 7 (0.5)	20 @ 7 (0.5)	
20 (6.0)	12 @ 40 (2.8)	12 @ 26 (1.8)	12 @ 18 (1.2)	9 @ 20 (1.4)	9 @ 20 (1.4)	6 @ 30 (2.1)	12 @ 40 (2.8)	12 @ 26 (1.8)	12 @ 16 (1.1)	12 @ 8 (0.6)	12 @ 40 (2.8)	12 @ 26 (1.8)	12 @ 18 (1.2)	6 @ 30 (2.1)	12 @ 40 (2.8)	12 @ 18 (1.2)	12 @ 8 (0.6)	20 @ 40 (2.8)	20 @ 18 (1.2)	20 @ 8 (0.6)	
25 (7.5)	12 @ 50 (3.5)	9 @ 75 (5.2)	9 @ 52 (3.6)	9 @ 32 (2.2)	9 @ 25 (1.7)	6 @ 38 (2.6)	12 @ 50 (3.5)	12 @ 32 (2.2)	12 @ 16 (1.1)	12 @ 10 (0.7)	12 @ 50 (3.5)	12 @ 32 (2.2)	12 @ 22 (1.5)	6 @ 38 (2.6)	12 @ 50 (3.5)	12 @ 22 (1.5)	12 @ 10 (0.7)	20 @ 50 (3.5)	20 @ 22 (1.5)	20 @ 10 (0.7)	
30 (9.0)		9 @ 100 (6.9)	9 @ 70 (4.8)	9 @ 50 (3.5)	9 @ 40 (2.8)																
40 (12.0)					20 @ 75 (5.2)																

Table 7. Ceiling-Level Protection Guidelines for Class 1, 2 and 3 Commodities in Open-Frame Rack Storage Arrangements

Max. Ceiling Height, ft (m)	Wet System, 160°F (70°C) Nominally Rated, Pendent Sprinklers											Wet System, 160°F (70°C) Nominally Rated, Upright Sprinklers				Dry System, 280°F (140°C) Nominally Rated, Upright Sprinklers				
	Quick Response						Standard Response					Quick Response				Standard Response				
	K11.2 (K160)	K14.0 (K200)	K16.8 (K240)	K22.4 (K320)	K25.2 (K360)	K25.2EC (K360EC)	K11.2 (K160)	K14.0 (K200)	K19.6 (K280)	K25.2 (K360)	K11.2 (K160)	K14.0 (K200)	K16.8 (K240)	K25.2EC (K360EC)	K11.2 (K160)	K16.8 (K240)	K25.2 (K360)	K11.2 (K160)	K16.8 (K240)	K25.2 (K360)
10 (3.0)	12 @ 7 (0.5)	9 @ 7 (0.5)	9 @ 7 (0.5)	9 @ 20 (1.4)	9 @ 20 (1.4)	6 @ 20 (1.4)	12 @ 7 (0.5)	9 @ 7 (0.5)	9 @ 16 (1.1)	9 @ 7 (0.5)	12 @ 7 (0.5)	9 @ 7 (0.5)	9 @ 7 (0.5)	6 @ 20 (1.4)	12 @ 7 (0.5)	9 @ 7 (0.5)	9 @ 7 (0.5)	16 @ 7 (0.5)	16 @ 7 (0.5)	16 @ 7 (0.5)
20 (6.0)	12 @ 10 (0.7)	12 @ 7 (0.5)	12 @ 7 (0.5)	9 @ 20 (1.4)	9 @ 20 (1.4)	6 @ 20 (1.4)	12 @ 10 (0.7)	12 @ 7 (0.5)	9 @ 16 (1.1)	9 @ 10 (0.7)	12 @ 10 (0.7)	12 @ 7 (0.5)	12 @ 7 (0.5)	6 @ 20 (1.4)	12 @ 10 (0.7)	12 @ 7 (0.5)	12 @ 7 (0.5)	16 @ 10 (0.7)	16 @ 7 (0.5)	16 @ 7 (0.5)
25 (7.5)	15 @ 16 (1.1)	12 @ 16 (1.1)	12 @ 11 (0.8)	9 @ 20 (1.4)	9 @ 20 (1.4)	6 @ 22 (1.5)	15 @ 16 (1.1)	15 @ 10 (0.7)	9 @ 16 (1.1)	9 @ 10 (0.7)	15 @ 16 (1.1)	12 @ 16 (1.1)	12 @ 11 (0.8)	6 @ 22 (1.5)	15 @ 16 (1.1)	15 @ 7 (0.5)	10 @ 20 (1.4)	20 @ 16 (1.1)	20 @ 7 (0.5)	20 @ 7 (0.5)
30 (9.0)	18 @ 50 (3.5)	12 @ 50 (3.5)	12 @ 35 (2.4)	9 @ 20 (1.4)	9 @ 20 (1.4)	6 @ 30 (2.1)	18 @ 50 (3.5)	18 @ 32 (2.2)	9 @ 16 (1.1)	9 @ 10 (0.7)	18 @ 50 (3.5)	12 @ 50 (3.5)	12 @ 35 (2.4)	6 @ 30 (2.1)	18 @ 50 (3.5)	18 @ 22 (1.5)	12 @ 20 (1.4)	25 @ 50 (3.5)	25 @ 22 (1.5)	25 @ 10 (0.7)
35 (10.5)		12 @ 75 (5.2)	12 @ 52 (3.6)	12 @ 29 (2.0)	12 @ 23 (1.6)	6 @ 60 (4.1) ^a			15 @ 25 (1.7)	9 @ 30 (2.1)				8 @ 40 (2.8)				See Section 2.3.6.1		
40 (12.0)		12 @ 75 (5.2)	12 @ 52 (3.6)	9 @ 50 (3.5)	9 @ 40 (2.8)				9 @ 30 (2.1)											

^a An acceptable alternative design is 8 @ 40 (2.8) when a 12 ft (3.6 m) maximum linear spacing is used

Table 8. Ceiling-Level Protection Guidelines for Class 4 and Cartoned Unexpanded Plastic Commodities in Open-Frame Rack Storage Arrangements

Max. Ceiling Height, ft (m)	Wet System, 160°F (70°C) Nominally Rated, Pendent Sprinklers											Wet System, 160°F (70°C) Nominally Rated, Upright Sprinklers				Dry System, 280°F (140°C) Nominally Rated, Upright Sprinklers				
	Quick Response						Standard Response					Quick Response				Standard Response				
	K11.2 (K160)	K14.0 (K200)	K16.8 (K240)	K22.4 (K320)	K25.2 (K360)	K25.2EC (K360EC)	K11.2 (K160)	K14.0 (K200)	K19.6 (K280)	K25.2 (K360)	K11.2 (K160)	K14.0 (K200)	K16.8 (K240)	K25.2EC (K360EC)	K11.2 (K160)	K16.8 (K240)	K25.2 (K360)	K11.2 (K160)	K16.8 (K240)	K25.2 (K360)
10 (3.0)	12 @ 7 (0.5)	9 @ 7 (0.5)	9 @ 7 (0.5)	9 @ 20 (1.4)	9 @ 20 (1.4)	6 @ 20 (1.4)	12 @ 7 (0.5)	9 @ 7 (0.5)	9 @ 16 (1.1)	9 @ 7 (0.5)	12 @ 7 (0.5)	9 @ 7 (0.5)	9 @ 7 (0.5)	6 @ 20 (1.4)	12 @ 7 (0.5)	9 @ 7 (0.5)	9 @ 7 (0.5)	16 @ 7 (0.5)	16 @ 7 (0.5)	16 @ 7 (0.5)
15 (4.5)	15 @ 16 (1.1)	12 @ 16 (1.1)	12 @ 11 (0.8)	9 @ 20 (1.4)	9 @ 20 (1.4)	6 @ 20 (1.4)	15 @ 16 (1.1)	12 @ 16 (1.1)	9 @ 16 (1.1)	10 @ 7 (0.5)	15 @ 16 (1.1)	12 @ 16 (1.1)	12 @ 11 (0.8)	6 @ 20 (1.4)	15 @ 16 (1.1)	12 @ 11 (0.8)	10 @ 7 (0.5)	20 @ 16 (1.1)	20 @ 7 (0.5)	20 @ 7 (0.5)
20 (6.0)	12 @ 30 (2.1)	12 @ 18 (1.2)	12 @ 13 (0.9)	9 @ 20 (1.4)	9 @ 20 (1.4)	6 @ 22 (1.5)	12 @ 30 (2.1)	12 @ 18 (1.2)	9 @ 16 (1.1)	12 @ 7 (0.5)	12 @ 30 (2.1)	12 @ 18 (1.2)	12 @ 13 (0.9)	6 @ 22 (1.5)	12 @ 30 (2.1)	12 @ 13 (0.9)	12 @ 7 (0.5)	20 @ 30 (2.1)	20 @ 13 (0.9)	20 @ 7 (0.5)
25 (7.5)	15 @ 65 (4.5)	9 @ 35 (2.4)	9 @ 24 (1.7)	9 @ 20 (1.4)	9 @ 20 (1.4)	6 @ 22 (1.5)	15 @ 65 (4.5)	15 @ 42 (2.9)	9 @ 16 (1.1)	12 @ 10 (0.7)	15 @ 65 (4.5)	12 @ 50 (3.5)	12 @ 35 (2.4)	6 @ 22 (1.5)	15 @ 65 (4.5)	15 @ 29 (2.0)	12 @ 20 (1.4)	20 @ 65 (4.5)	20 @ 29 (2.0)	20 @ 13 (0.9)
30 (9.0)		12 @ 50 (3.5)	12 @ 35 (2.4)	9 @ 20 (1.4)	9 @ 20 (1.4)	6 @ 30 (2.1)			9 @ 16 (1.1)	12 @ 15 (1.0)				6 @ 30 (2.1)			12 @ 20 (1.4)			30 @ 20 (1.4)
35 (10.5)		12 @ 75 (5.2)	12 @ 52 (3.6)	12 @ 29 (2.0)	12 @ 23 (1.6)	6 @ 60 (4.1) ^a			15 @ 25 (1.7)	9 @ 30 (2.1)				8 @ 40 (2.8)						
40 (12.0)		12 @ 75 (5.2)	12 @ 52 (3.6)	9 @ 50 (3.5)	9 @ 40 (2.8)				9 @ 30 (2.1)											

^a An acceptable alternative design is 8 @ 40 (2.8) when a 12 ft (3.6 m) maximum linear spacing is used

Table 9. Ceiling-Level Protection Guidelines for Cartoned Expanded Plastic Commodities in Open-Frame Rack Storage Arrangements

Max. Ceiling Height, ft (m)	Wet System, 160°F (70°C) Nominally Rated, Pendent Sprinklers										Wet System, 160°F (70°C) Nominally Rated, Upright Sprinklers					Dry System, 280°F (140°C) Nominally Rated, Upright Sprinklers					
	Quick Response						Standard Response				Quick Response					Standard Response			Standard Response		
	K11.2 (K160)	K14.0 (K200)	K16.8 (K240)	K22.4 (K320)	K25.2 (K360)	K25.2EC (K360EC)	K11.2 (K160)	K14.0 (K200)	K19.6 (K280)	K25.2 (K360)	K11.2 (K160)	K14.0 (K200)	K16.8 (K240)	K25.2EC (K360EC)	K11.2 (K160)	K16.8 (K240)	K25.2 (K360)	K11.2 (K160)	K16.8 (K240)	K25.2 (K360)	
10 (3.0)	15 @ 10 (0.7)	15 @ 7 (0.5)	15 @ 7 (0.5)	9 @ 20 (1.4)	9 @ 20 (1.4)	6 @ 20 (1.4)	15 @ 10 (0.7)	15 @ 7 (0.5)	12 @ 16 (1.1)	15 @ 7 (0.5)	15 @ 10 (0.7)	15 @ 7 (0.5)	15 @ 7 (0.5)	6 @ 20 (1.4)	15 @ 10 (0.7)	15 @ 7 (0.5)	15 @ 7 (0.5)	20 @ 10 (0.7)	20 @ 7 (0.5)	20 @ 7 (0.5)	
20 (6.0)	18 @ 28 (1.9)	12 @ 18 (1.2)	12 @ 13 (0.9)	9 @ 20 (1.4)	9 @ 20 (1.4)	9 @ 21 (1.4)	18 @ 28 (1.9)	15 @ 18 (1.2)	15 @ 16 (1.1)	15 @ 7 (0.5)	15 @ 50 (3.5)	12 @ 50 (3.5)	12 @ 35 (2.4)	8 @ 35 (2.4)	15 @ 50 (3.5)	15 @ 22 (1.5)	15 @ 10 (0.7)	20 @ 50 (3.5)	20 @ 22 (1.5)	20 @ 10 (0.7)	
25 (7.5)		12 @ 35 (2.4)	12 @ 24 (1.7)	10 @ 20 (1.4)	9 @ 20 (1.4)	8 @ 60 (4.1)		15 @ 50 (3.5)	15 @ 25 (1.7)	15 @ 15 (1.0)		12 @ 50 (3.5)	12 @ 35 (2.4)								
30 (9.0)		12 @ 50 (3.5)	12 @ 35 (2.4)	12 @ 25 (1.7)	12 @ 20 (1.4)																
40 (12.0)				12 @ 75 (5.2)	12 @ 60 (4.1)																

Table 10. Ceiling-Level Protection Guidelines for Uncartoned Unexpanded Plastic Commodities in Open-Frame Rack Storage Arrangements

Max. Ceiling Height, ft (m)	Wet System, 160°F (70°C) Nominally Rated, Pendent Sprinklers										Wet System, 160°F (70°C) Nominally Rated, Upright Sprinklers					Dry System, 280°F (140°C) Nominally Rated, Upright Sprinklers					
	Quick Response						Standard Response				Quick Response					Standard Response			Standard Response		
	K11.2 (K160)	K14.0 (K200)	K16.8 (K240)	K22.4 (K320)	K25.2 (K360)	K25.2EC (K360EC)	K11.2 (K160)	K14.0 (K200)	K19.6 (K280)	K25.2 (K360)	K11.2 (K160)	K14.0 (K200)	K16.8 (K240)	K25.2EC (K360EC)	K11.2 (K160)	K16.8 (K240)	K25.2 (K360)	K11.2 (K160)	K16.8 (K240)	K25.2 (K360)	
10 (3.0)	15 @ 10 (0.7)	15 @ 7 (0.5)	15 @ 7 (0.5)	9 @ 20 (1.4)	9 @ 20 (1.4)	6 @ 20 (1.4)	15 @ 10 (0.7)	15 @ 7 (0.5)	12 @ 16 (1.1)	15 @ 7 (0.5)	15 @ 10 (0.7)	15 @ 7 (0.5)	15 @ 7 (0.5)	6 @ 20 (1.4)	15 @ 10 (0.7)	15 @ 7 (0.5)	15 @ 7 (0.5)	20 @ 10 (0.7)	20 @ 7 (0.5)	20 @ 7 (0.5)	
15 (4.5)	15 @ 50 (3.5)	12 @ 32 (2.2)	12 @ 22 (1.5)	9 @ 25 (1.7)	9 @ 20 (1.4)	6 @ 60 (4.1)	15 @ 50 (3.5)	12 @ 50 (3.5)	12 @ 25 (1.7)	12 @ 15 (1.0)	15 @ 50 (3.5)	15 @ 32 (2.2)	15 @ 22 (1.5)	8 @ 35 (2.4)	15 @ 50 (3.5)	15 @ 22 (1.5)	15 @ 10 (0.7)	20 @ 50 (3.5)	20 @ 22 (1.5)	20 @ 10 (0.7)	
20 (6.0)		9 @ 50 (3.5)	9 @ 35 (2.4)	9 @ 25 (1.7)	9 @ 20 (1.4)	6 @ 60 (4.1)		12 @ 50 (3.5)	12 @ 25 (1.7)	12 @ 15 (1.0)											
25 (7.5)		10 @ 50 (3.5)	10 @ 35 (2.4)	10 @ 25 (1.7)	10 @ 20 (1.4)																
30 (9.0)		15 @ 50 (3.5)	15 @ 35 (2.4)	10 @ 50 (3.5)	10 @ 40 (2.8)																
40 (12.0)				12 @ 75 (5.2)	12 @ 60 (4.1)																

Table 11. Ceiling-Level Protection Guidelines for Uncartoned Expanded Plastic Commodities in Open-Frame Rack Storage Arrangements

Protection of Uncartoned Expanded Plastic Commodities in Open-Frame Storage Racks; No. of AS @ psi (bar)																					
Max. Ceiling Height, ft (m)	Wet System, 160°F (70°C) Nominally Rated, Pendent Sprinklers										Wet System, 160°F (70°C) Nominally Rated, Upright Sprinklers						Dry System, 280°F (140°C) Nominally Rated, Upright Sprinklers				
	Quick Response					Standard Response					Quick Response				Standard Response		Standard Response				
	K11.2 (K160)	K14.0 (K200)	K16.8 (K240)	K22.4 (K320)	K25.2 (K360)	K25.2EC (K360EC)	K11.2 (K160)	K14.0 (K200)	K19.6 (K280)	K25.2 (K360)	K11.2 (K160)	K14.0 (K200)	K16.8 (K240)	K25.2EC (K360EC)	K11.2 (K160)	K16.8 (K240)	K25.2 (K360)	K11.2 (K160)	K16.8 (K240)	K25.2 (K360)	
10 (3.0)	15 @ 10 (0.7)	15 @ 7 (0.5)	15 @ 7 (0.5)	9 @ 20 (1.4)	9 @ 20 (1.4)	6 @ 20 (1.4)	15 @ 10 (0.7)	15 @ 7 (0.5)	12 @ 16 (1.1)	15 @ 7 (0.5)	15 @ 10 (0.7)	15 @ 7 (0.5)	15 @ 7 (0.5)	6 @ 20 (1.4)	15 @ 10 (0.7)	15 @ 7 (0.5)	15 @ 7 (0.5)	25 @ 10 (0.7)	25 @ 7 (0.5)	25 @ 7 (0.5)	
15 (4.5)	15 @ 50 (3.5)	12 @ 32 (2.2)	12 @ 22 (1.5)	9 @ 25 (1.7)	9 @ 20 (1.4)	8 @ 35 (2.4)	15 @ 50 (3.5)	15 @ 32 (2.2)	15 @ 16 (1.1)	15 @ 10 (0.7)	15 @ 50 (3.5)	15 @ 32 (2.2)	15 @ 22 (1.5)	8 @ 35 (2.4)	15 @ 50 (3.5)	15 @ 22 (1.5)	15 @ 10 (0.7)	25 @ 50 (3.5)	25 @ 22 (1.5)	25 @ 10 (0.7)	
25 (7.5)		12 @ 75 (5.2)	12 @ 52 (3.6)	9 @ 32 (2.2)	9 @ 25 (1.7)																
30 (9.0)		12 @ 100 (6.9)	12 @ 70 (4.8)	12 @ 50 (3.5)	12 @ 40 (2.8)																
40 (12.0)					20 @ 75 (5.2)																

2.3.3.7.3 Ceiling Heights in Excess of Those Indicated in Protection Tables for Ceiling-Level Storage Sprinklers

When ceiling heights at storage facilities are in excess of those indicated in the applicable protection table from Section 2.3.3.7.2, see the guidelines in Section 2.3.3.7.3.1 for storage arrangements involving racks, or Section 2.3.3.7.3.2 for solid-piled, palletized, shelf, and bin-box storage arrangements.

2.3.3.7.3.1 Ceiling Heights in Excess of Those Indicated in Protection Tables for Ceiling-Level Storage Sprinklers Protecting Rack Storage

When ceiling heights at storage facilities are in excess of what is indicated in the applicable protection table in Section 2.3.3.7.2 for the commodity being protected, a ceiling-only sprinkler system is not an option.

Implement one of the two options listed below when ceiling-only options are not available.

2.3.3.7.3.1.1. Option 1: Installation of a False Ceiling

Install a noncombustible false ceiling directly over and at least 15 ft (4.5 m) beyond the storage area. Design the false ceiling in accordance with Data Sheet 1-12, *Ceilings and Concealed Spaces*. Provide sprinklers under the false ceiling and design them based on the guidelines indicated in the applicable protection table for the height above the floor over which the false ceiling has been installed. If, however, in-racks are still needed, even in the presence of a false ceiling, design the sprinklers under the false ceiling in accordance with Table 13 as described in Section 2.3.4.8.2.

2.3.3.7.3.1.2. Option 2: Installation of In-Rack Sprinklers

Follow the guidelines in Section 2.3.4.6 to determine the acceptable horizontal layout of the in-rack sprinklers, and Section 2.3.4.7 for the vertical increments in which the in-rack sprinklers can be installed.

If there is more than 20 ft (6.0 m) of vertical clearance between the top of storage and the ceiling above, supplement the existing in-rack sprinkler arrangement obtained from Sections 2.3.4.6 and 2.3.4.7 by installing in-rack sprinklers at the top tier level of the storage rack. Use an in-rack arrangement in accordance with Figures 11, 13, and 14, depending on the rack type. If a horizontal barrier is provided above this top level of in-rack sprinklers, Figure 12 can be used as an alternative for double-row racks, and Figure 10 can be used as an alternative for multiple-row racks. Design the ceiling-level sprinklers in accordance with Table 13 (Section 2.3.4.8.2) based on an IRAS(E) in-rack sprinkler arrangement and ceiling clearance of 20 ft (6.0 m). Limit the storage on the top tier to a maximum of 5 ft (1.5 m).

2.3.3.7.3.2 Ceiling Heights in Excess of Those Indicated in Protection Tables for Ceiling-Level Storage Sprinklers Protecting Solid-Piled, Palletized, Shelf, or Bin-Box Storage Arrangements

When ceiling heights at storage facilities are in excess of what is indicated in the applicable protection table in Section 2.3.3.7.2 for the commodity being protected, a ceiling-only sprinkler system is not an option.

Implement one of the two options listed below when ceiling-only options are not available.

2.3.3.7.3.2.1 Option 1: Installation of a False Ceiling

Install a noncombustible false ceiling directly over and at least 15 ft (4.5 m) beyond the storage area. Design the false ceiling in accordance with Data Sheet 1-12, *Ceilings and Concealed Spaces*. Provide sprinklers under the false ceiling and design them based on the guidelines indicated in the applicable protection table for the height above the floor over which the false ceiling has been installed.

2.3.3.7.3.2.2 Option 2: Installation of In-Rack Sprinklers

If a false ceiling as indicated in Option 1 cannot be installed, the storage arrangement will need to be converted to a rack storage arrangement protected with in-rack sprinklers. Follow the guidelines in Section 2.3.3.7.3.1.2 for the installation of in-rack sprinklers within these storage racks.

2.3.4 In-Rack Sprinklers (IRAS)

2.3.4.1 General

Protection options for rack storage arrangements are based on ceiling-only sprinkler systems, or a combination of ceiling-level and in-rack sprinkler systems. When in-rack sprinklers are needed, they can be used in combination with any of the ceiling sprinklers listed in Tables 7 through 11.

2.3.4.1.1 When in-rack sprinklers are needed as a supplement to ceiling-level sprinklers, as outlined in Section 2.3.4.2, use FM Approved in-rack sprinklers listed in the *Approval Guide*, an online resource of FM Approvals, under the heading of Storage Sprinklers (In-Racks).

2.3.4.1.2 If in-rack sprinklers are recommended in Section 2.3.4.2 for the rack storage arrangement and commodity hazard involved, use the following procedure to determine the recommended protection for both the ceiling and in-rack sprinkler systems:

1. Determine the available horizontal in-rack sprinkler arrangements per Section 2.3.4.6
2. Determine the available vertical increments between in-rack sprinkler levels per Section 2.3.4.7
3. Determine the in-rack sprinkler system design guidelines per Section 2.3.4.8.1
4. Determine the ceiling-level sprinkler system design guidelines when supplemented with in-rack sprinklers per Section 2.3.4.8.2
5. Determine the hose demand and duration for the combined ceiling-level and in-rack sprinkler system per Section 2.3.5.

2.3.4.1.3 See Sections 2.3.6.3 through 2.3.6.7 for additional in-rack sprinkler protection recommendations that supplement the recommendations obtained from this section.

2.3.4.2 When In-Rack Sprinklers are Needed

The need for in-rack sprinklers is dependent on several parameters, including commodity hazard, ceiling height, available water supply, the presence of solid shelves, and the width and location of flue spaces. See Appendix A for an explanation of how the width and location of flue spaces affects the classification of open-frame racking. The following guidelines indicate when in-rack sprinklers are needed. Also see Figure 3 for a flowchart summarizing when in-rack sprinklers are recommended. In-rack sprinklers may also be needed if open-top containers are present; see Section 2.2.5.1 for guidance.

2.3.4.2.1 Open-Frame Racks

The ceiling-level protection tables in Section 2.3.3.7 are based on storage racks, fixed-in-place or portable, that meet the definition of open-frame. In-rack sprinklers are needed when the ceiling-level protection tables do not offer a design option for a given ceiling height.

In-rack sprinklers are also needed if the available water supply cannot provide the required flow and pressure for any ceiling-only protection option.

2.3.4.2.2 Racks With Solid Shelves 20 to 64 ft² (2.0 to 6.0 m²) in Area

In-rack sprinklers are needed within storage racks having solid shelves 20 to 64 ft² (2.0 to 6.0 m²) in surface area under the following conditions:

1. Class 1 through 4 and cartoned plastics are stored higher than 15 ft (4.5 m) under a ceiling up to 30 ft (9.0 m) high, or
2. Uncartoned plastics are stored higher than 10 ft (3.0 m) under a ceiling up to 30 ft (9.0 m) high, or
3. The ceiling height exceeds 30 ft (9.0 m), or
4. The available water supply cannot provide the flow and pressure needed for any ceiling-only protection option that is acceptable in the presence of solid shelves 20 to 64 ft² (2.0 to 6.0 m²) in surface area.

2.3.4.2.3 Racks With Solid Shelves Greater than 64 ft² (6.0 m²) in Area

In-rack sprinklers are needed within storage racks at all tier levels equipped with solid shelves greater than 64 ft² (6.0 m²) in area.

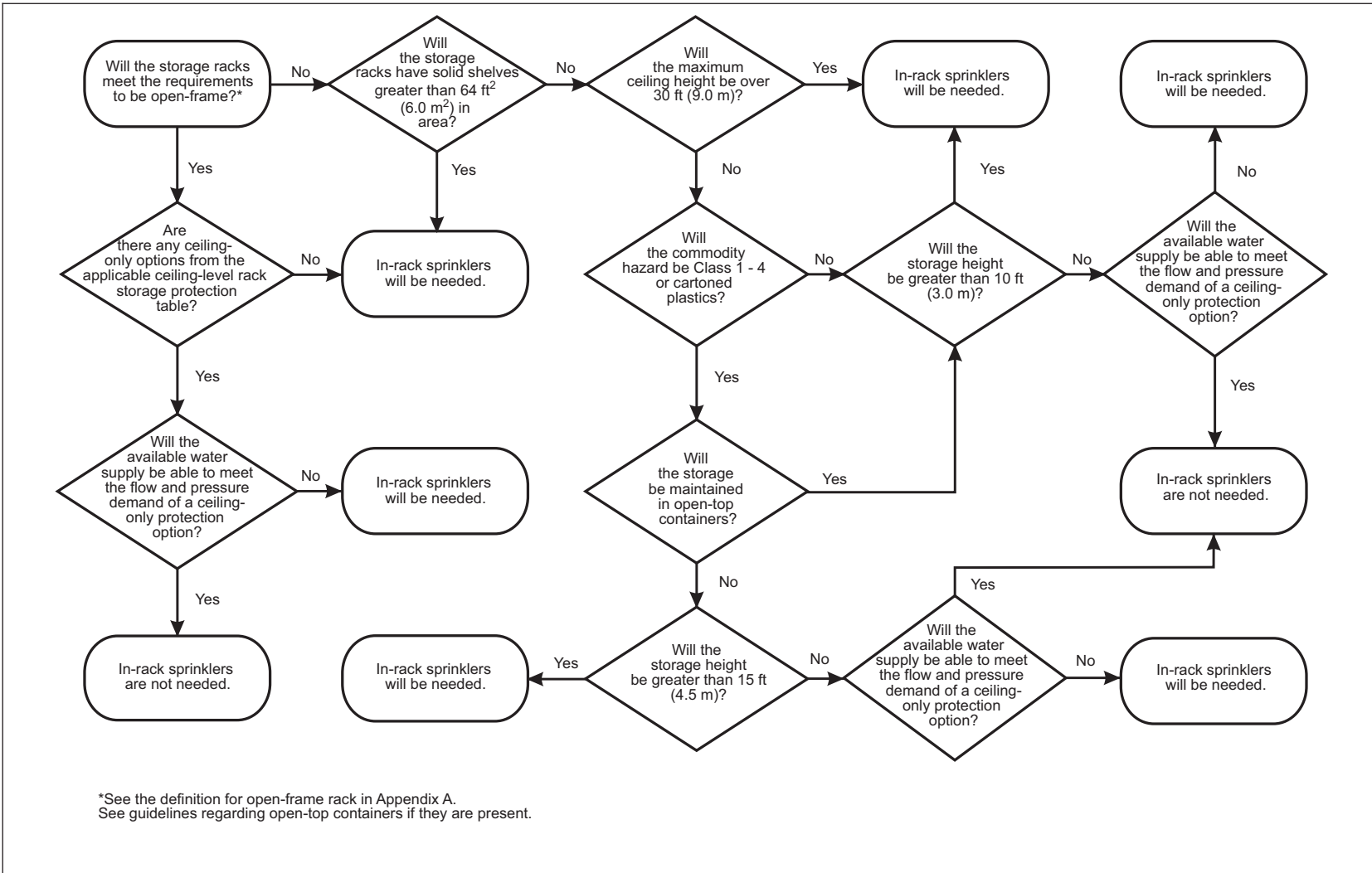

Fig. 3. Flowchart for evaluating the need for in-rack sprinklers

2.3.4.3 K-Factors, Nominal Temperature Rating, and RTI Rating of In-Rack Storage Sprinklers

2.3.4.3.1 Use nominally rated 160°F (70°C) FM Approved in-rack sprinklers for all in-rack sprinkler installations.

2.3.4.3.2 Use in-rack sprinklers listed as quick-response when installing K14.0 (K200) or smaller sprinklers. In-rack sprinklers with larger K-factor values can be either quick-response or standard-response.

2.3.4.3.3 Use a minimum K8.0 (K115) for in-rack sprinkler design flows greater than 30 gpm (115 L/min).

2.3.4.4 In-Rack Sprinkler System Types

In-rack sprinkler systems can be wet-pipe, dry-pipe, preaction, or refrigerated area. Note, however, that grid-type piping configurations are only recommended for wet-pipe sprinkler systems.

2.3.4.5 General Guidelines for Positioning of In-Rack Sprinklers

2.3.4.5.1 Locate all in-rack sprinklers within the rack storage structure. In-rack sprinklers may be located outside the rack storage structure of a single-row rack that is located within 12 in. (300 mm) horizontally of a wall. The in-rack sprinklers must be no more than 6 in. (150 mm) horizontally away from the rack structure as well as no more than 3 in. (75 mm) offset from the transverse flue space intersection they are intended to protect.

2.3.4.5.2 For in-rack sprinkler arrangements per Figures 9 and 12, or for in-rack sprinklers located outside the rack storage structure as outlined in Section 2.3.4.5.1, position the in-rack sprinklers so they are not directly behind rack uprights and are not more than 3 in. (75 mm) offset horizontally from the transverse flue space intersection they are intending to protect.

2.3.4.5.3 At each tier level where in-rack sprinklers are needed, position the in-rack sprinkler deflector at or just below the bottom of the rack's horizontal support member when it is under full load conditions.

2.3.4.5.4 Arrange sprinkler piping and in-rack sprinklers to avoid mechanical damage, but ensure proper distribution from the in-rack sprinkler can be achieved. Prior to installing in-rack sprinklers, check the proposed in-rack sprinkler locations to ensure both adequate protection against mechanical damage and proper sprinkler discharge are provided.

2.3.4.6 Horizontal Lay-Outs of In-Rack Sprinklers

There are two basic horizontal layouts for in-rack sprinklers. They are as follows:

- IRAS(E0), which represents in-rack sprinklers spaced horizontally at every other transverse flue space intersection between pallet loads
- IRAS(E), which represents in-rack sprinklers spaced horizontally at every transverse flue space intersection between pallet loads

The type of horizontal in-rack sprinkler layout acceptable for installation will be dependent on:

- the type of rack (single-row, double-row, or multiple-row) being protected,
- the commodity being protected,
- whether open-top containers are present,
- the maximum ceiling height of the storage area,
- whether a minimum 6 in. (150 mm) vertical clearance is provided between the top of storage and the in-rack sprinkler deflector, and
- whether horizontal barriers are to be installed.

This data sheet provides figures showing plan views for both IRAS(E0) and IRAS(E) arrangements to assist in the proper location and spacing of the in-rack sprinklers. Figures are provided for (1) single-row, (2) double-row, and (3) multiple-row storage racks and are described in the following sections. These figures use squares to represent nominal 20 ft² (2.0 m²) pallet loads and the flue spaces between them. See Sections 2.3.4.6.1 and 2.3.4.6.2 for the minimum and maximum recommended distances between in-rack sprinklers.

When solid shelves are present and in-rack sprinklers are needed using horizontal lay-outs per Sections 2.3.4.6.1 and 2.3.4.6.2, position the in-rack sprinklers as close to the shelf openings as possible.

See the following figures for flowcharts that summarize the specific horizontal in-rack sprinkler arrangements that are recommended for the indicated rack storage type:

Figure 4: Single-Row Racks

Figure 5: Double-Row Racks

Figure 6: Double-Row Racks That Need an IRAS(E) In-Rack Sprinkler Arrangement

Figure 7: Multiple-Row Racks

See Section 2.3.4.9 for guidelines on the in-rack sprinkler layout for Scheme 8-9A.

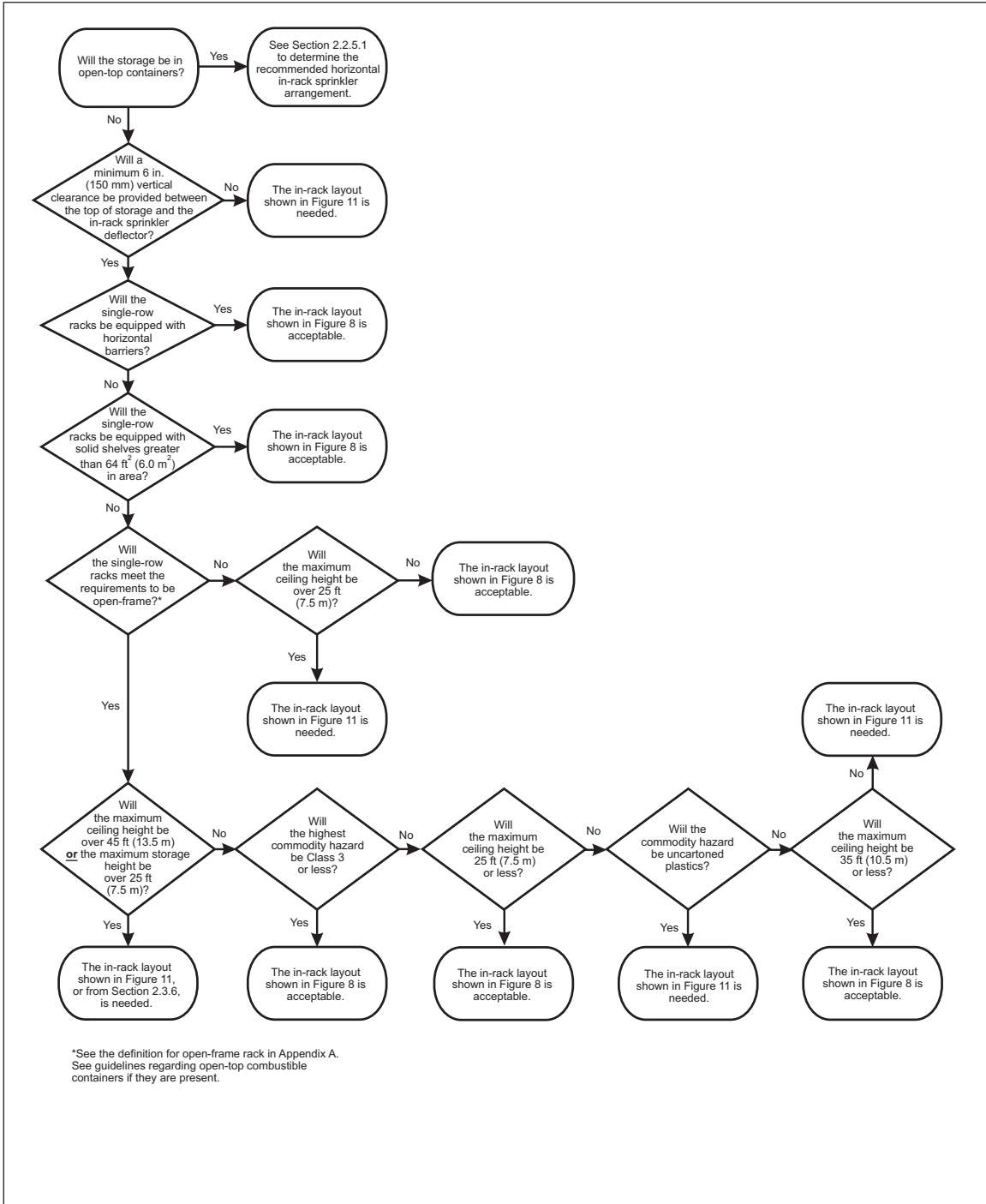

Fig. 4. Recommended horizontal in-rack sprinkler arrangements for single-row racks

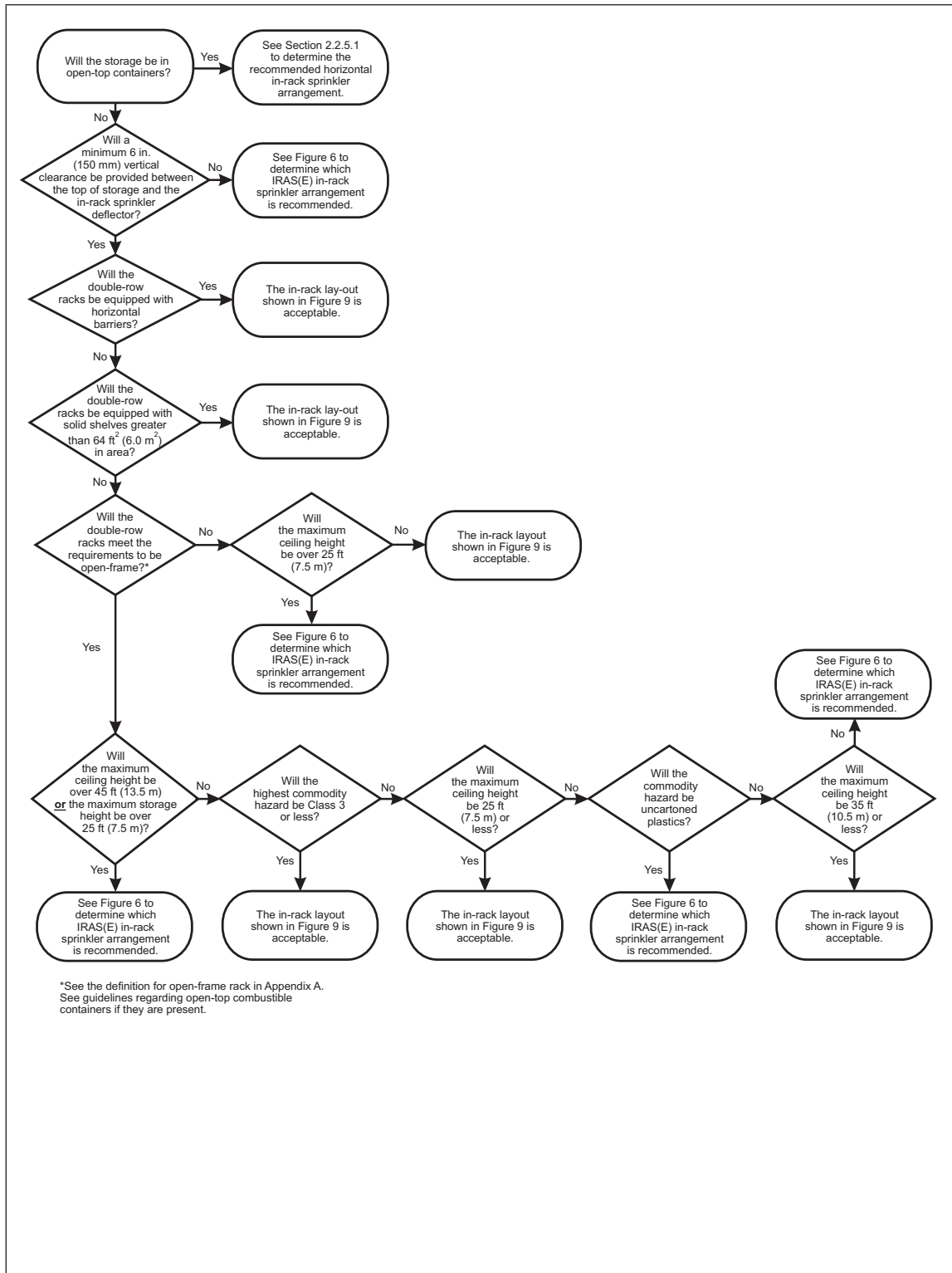

Fig. 5. Recommended horizontal in-rack sprinkler arrangements for double-row racks

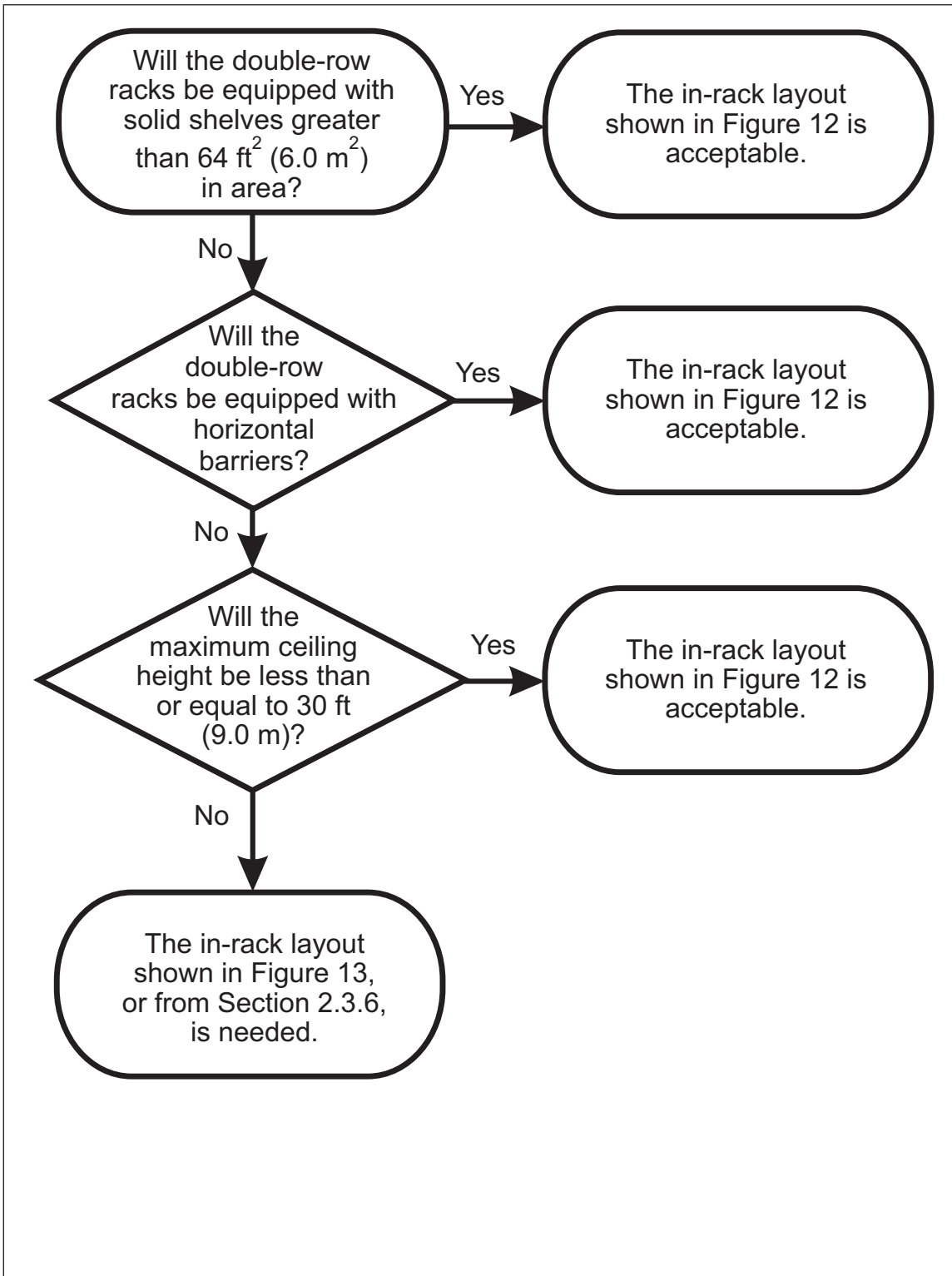

Fig. 6. Recommended horizontal IRAS(E) in-rack sprinkler arrangements for double-row racks

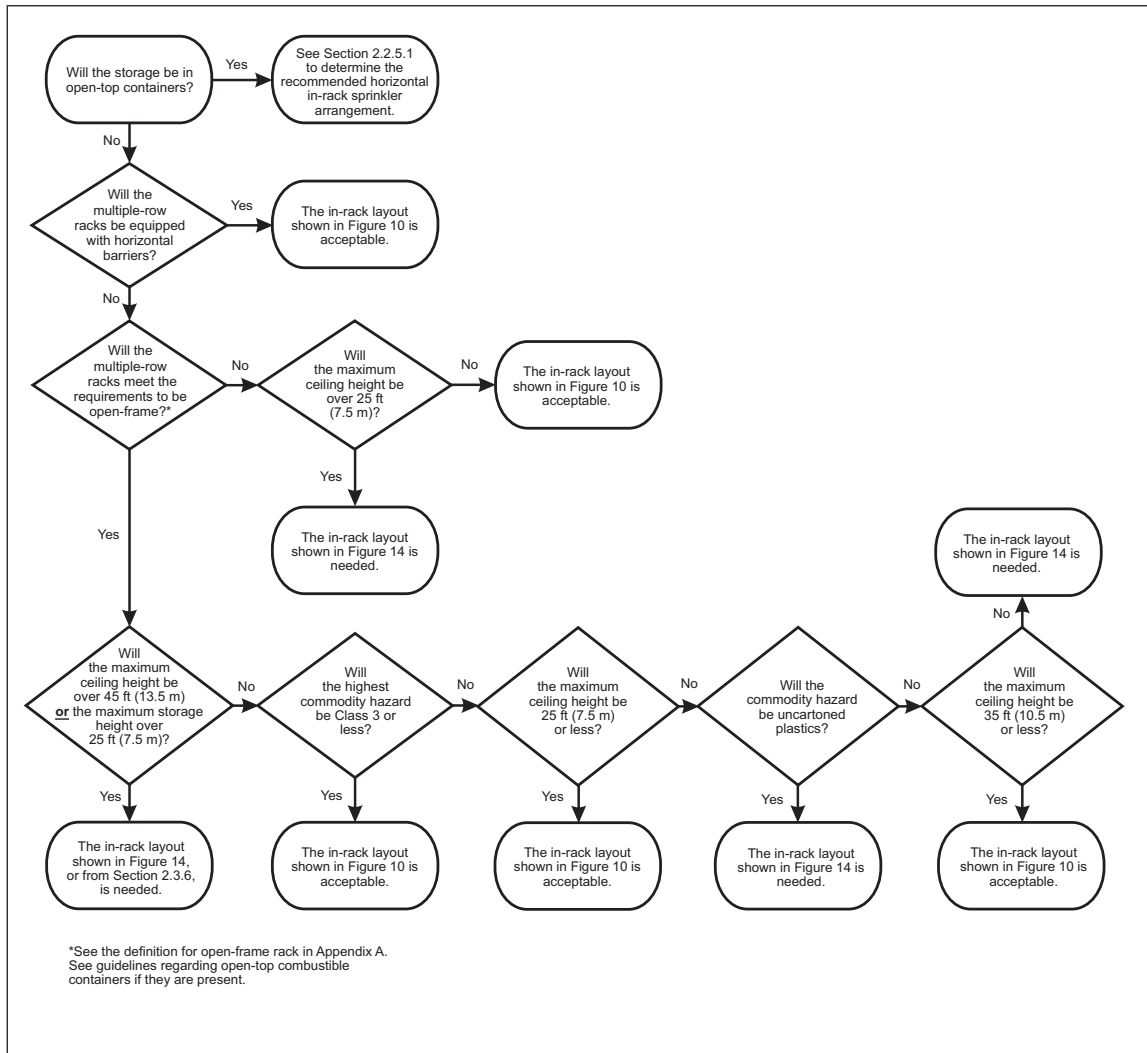

Fig. 7. Recommended horizontal in-rack sprinkler arrangements for multiple-row racks

2.3.4.6.1 Horizontal Lay-Outs for IRAS(EO) In-Rack Sprinkler Arrangements

2.3.4.6.1.1 Figures 8, 9, and 10 represent IRAS(EO) in-rack sprinkler arrangements for single-row, double-row, and multiple-row rack storage arrangements, respectively. Figure 9 applies to double-row racks that are no deeper (aisle face to aisle face) than 9 ft (2.7 m). These types of in-rack sprinkler arrangements can be used when a minimum 6 in. (150 mm) vertical clearance is provided between the in-rack sprinkler deflector and the top of storage in combination with any of the following additional conditions:

1. Class 1, 2 or 3 commodities in closed-top containers are maintained in open-framed racks, the storage height does not exceed 25 ft (7.5 m), and the ceiling height does not exceed 45 ft (13.5 m), or
2. Class 4 or cartoned plastic commodities in closed-top containers are maintained in open-framed racks, the storage height does not exceed 25 ft (7.5 m) and the ceiling height does not exceed 35 ft (10.5 m), or
3. Closed-top uncartoned plastic commodities are maintained in open-framed racks and the ceiling height does not exceed 25 ft (7.5 m), or
4. Storage racks are equipped with solid shelves not exceeding 64 ft² (6.0 m²) in area and the ceiling height does not exceed 25 ft (7.5 m), or
5. Closed-top container storage is maintained in racks equipped with horizontal barriers.

8-9 Storage of Class 1, 2, 3, 4 and Plastic Commodities

Note that the minimum 6 in. (150 mm) vertical clearance between the deflector of the in-rack sprinkler and the top of storage is not required for multi-row racks.

If open-top containers are present, see Section 2.2.5.1 to determine if the guidelines outlined above would be affected.

2.3.4.6.1.2 When arranging protection in accordance with an IRAS(EO) arrangement, ensure the maximum horizontal distance between every other transverse flue space is 10 ft (3.0 m). If the horizontal distance between every other transverse flue space is greater than 10 ft (3.0 m), follow the guidelines in Section 2.3.4.6.2 for installing an IRAS(E) arrangement.

2.3.4.6.1.3 Ensure the minimum distance between every other transverse flue space is 4 ft (1.2 m) minimum; otherwise, in-rack sprinklers can be installed at every fourth transverse flue space.

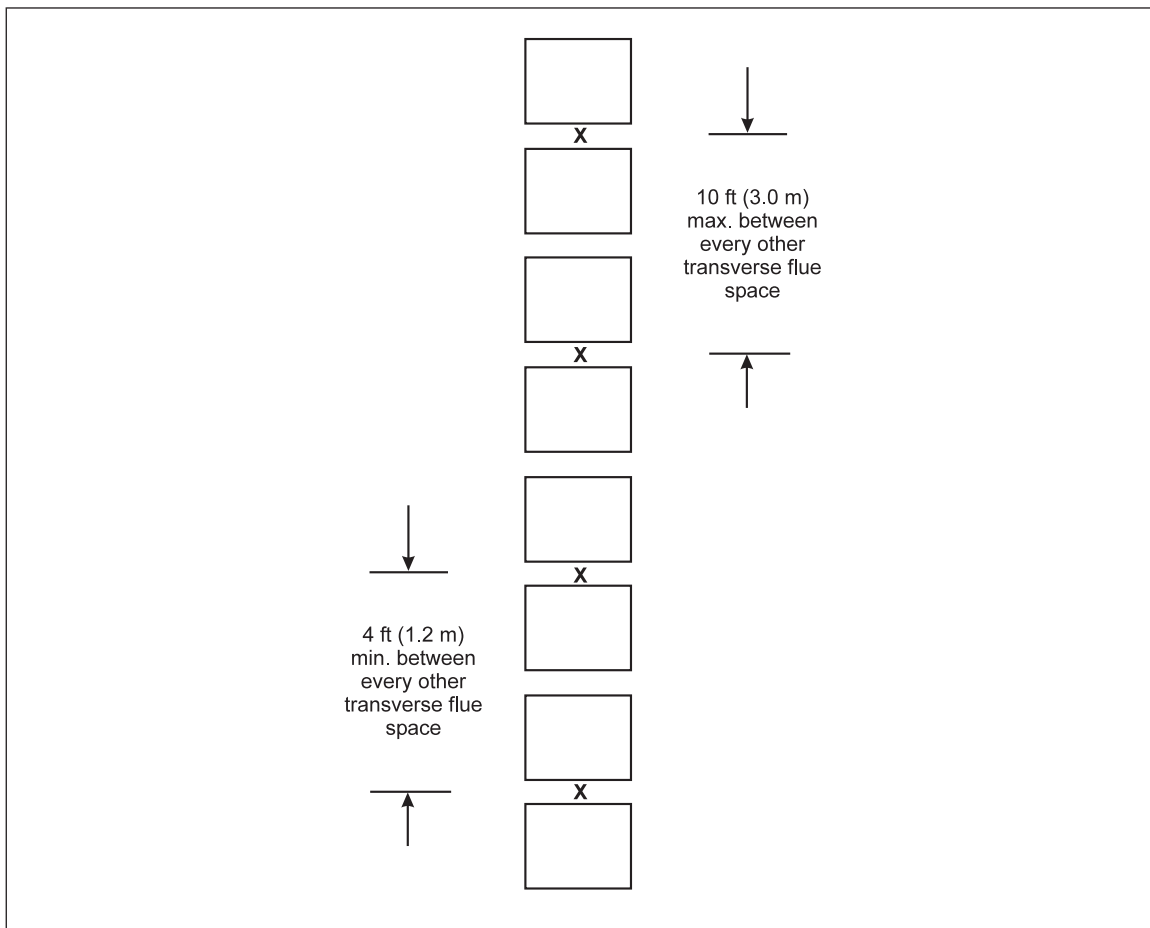

Fig. 8. Plan view of IRAS(EO) in-rack sprinkler arrangement for single-row racks

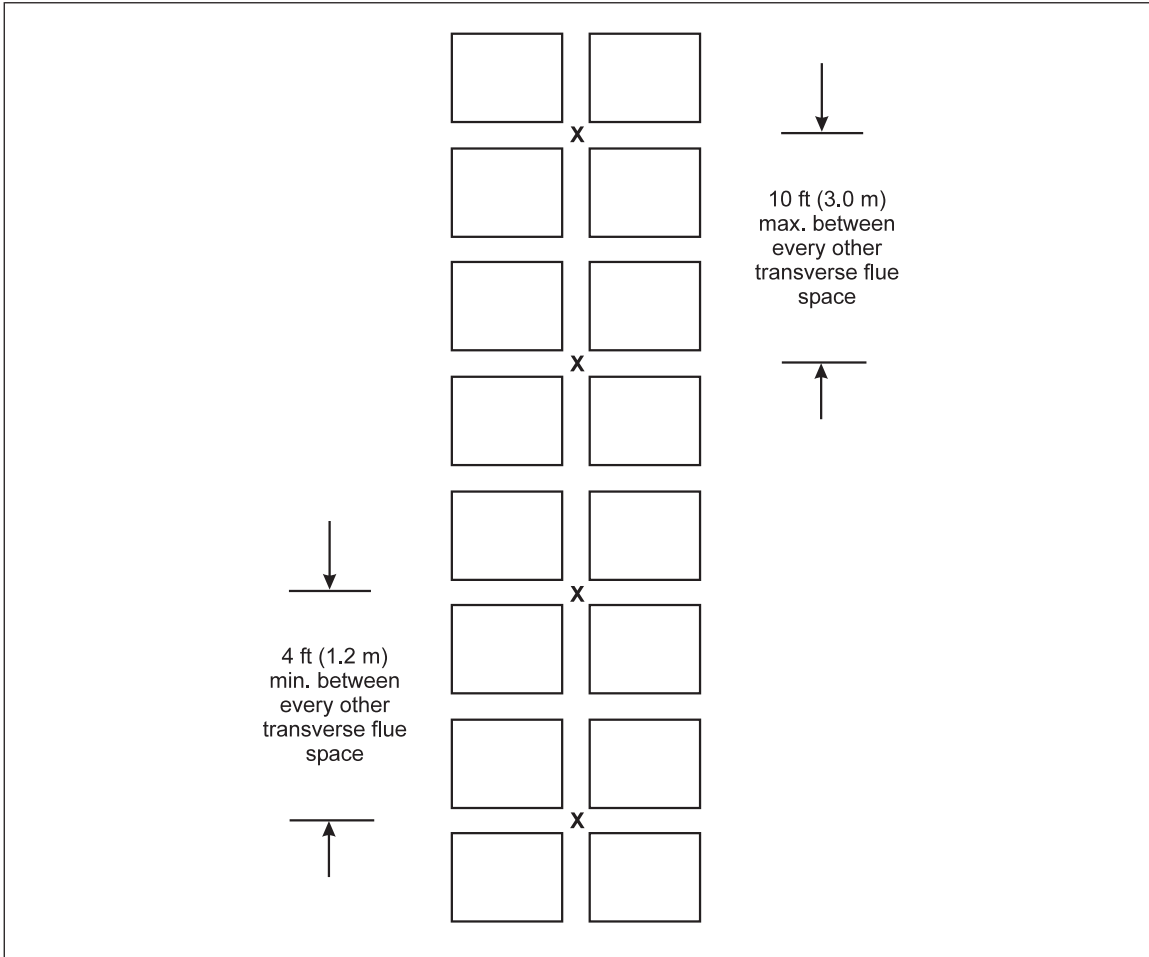

Fig. 9. Plan view of IRAS(EO) in-rack sprinkler arrangement for double-row racks

8-9 Storage of Class 1, 2, 3, 4 and Plastic Commodities

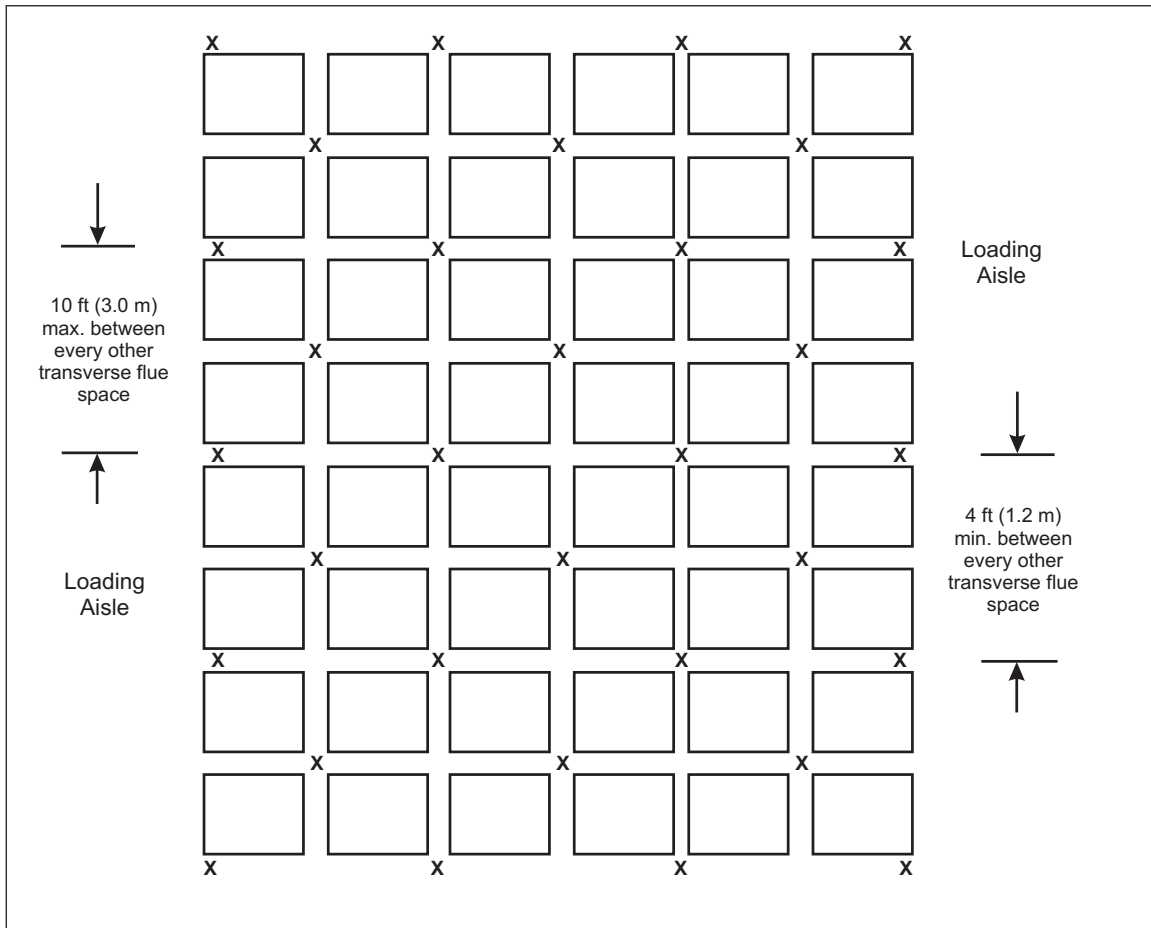

Fig. 10. Plan view of IRAS(EO) in-rack sprinkler arrangement for multiple-row racks

2.3.4.6.2 Horizontal Lay-Outs for IRAS(E) In-Rack Sprinkler Arrangements

2.3.4.6.2.1 Figures 11, 12, 13, and 14 represent IRAS(E) arrangements for single-row, double-row, and multiple-row rack storage arrangements. IRAS(E) horizontal in-rack arrangements may be used whenever IRAS(EO) arrangements are acceptable, but are required for conditions where IRAS(EO) arrangements are unacceptable.

2.3.4.6.2.2 The in-rack sprinkler arrangement indicated in Figure 12 is acceptable for double-row racks up to 9 ft (2.7 m) deep. It is also acceptable for double-row racks up to 12 ft (3.6 m) deep for ceiling heights not exceeding 30 ft (9.0 m). For open-frame double-row racks over 9 ft (2.7 m) deep and up to 12 ft (3.6 m) deep not equipped with horizontal barriers under ceilings higher than 30 ft (9.0 m), use the in-rack arrangement indicated in Figure 13.

2.3.4.6.2.3 When arranging protection in accordance with an IRAS(E) arrangement, ensure the maximum horizontal distance between transverse flue spaces is 8 ft (2.4 m). If the horizontal distance between every transverse flue space is greater than 8 ft (2.4 m), install in-rack sprinklers horizontally at the midpoints between transverse flue spaces such that the horizontal distance between in-rack sprinklers does not exceed 8 ft (2.4 m).

2.3.4.6.2.4 Ensure the minimum distance between transverse flue spaces is greater than 2 ft (0.6 m); otherwise, in-rack sprinklers can be installed at every other transverse flue space.

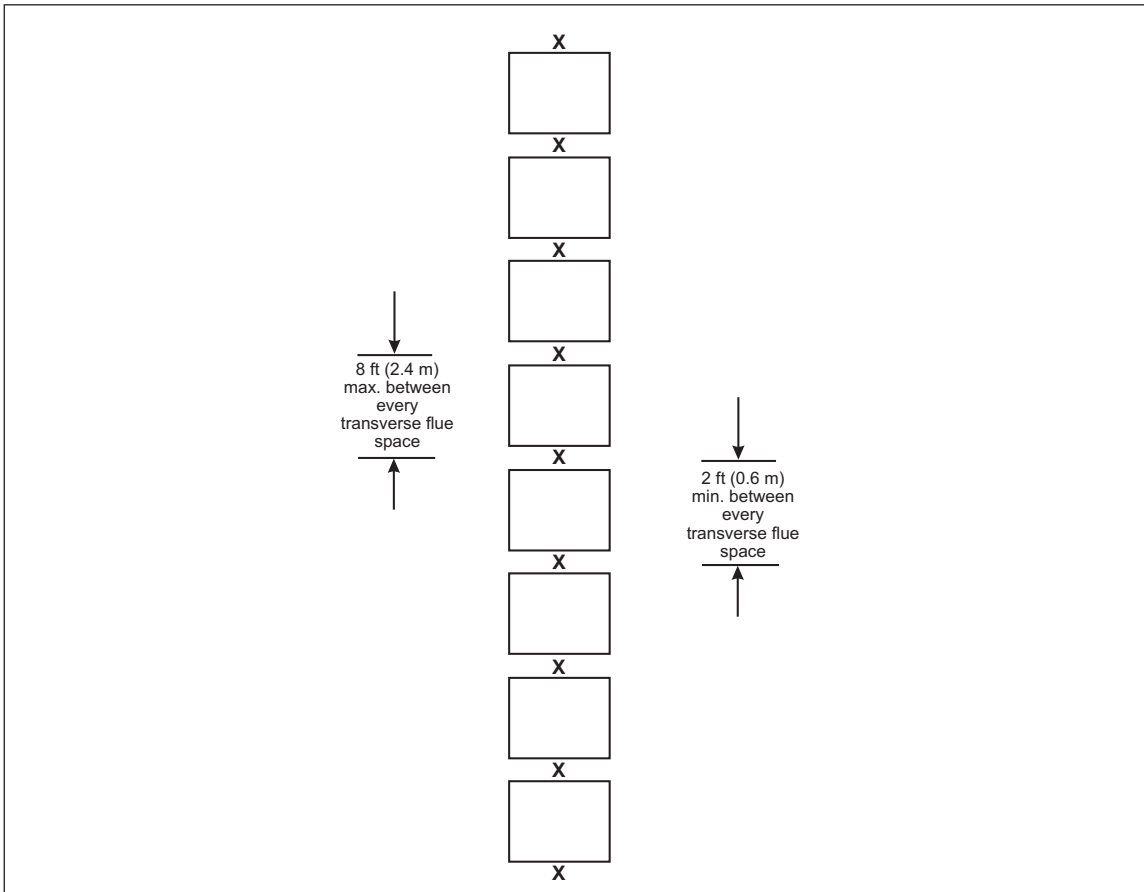

Fig. 11. Plan view of IRAS(E) in-rack sprinkler arrangement for single-row racks

8-9 Storage of Class 1, 2, 3, 4 and Plastic Commodities

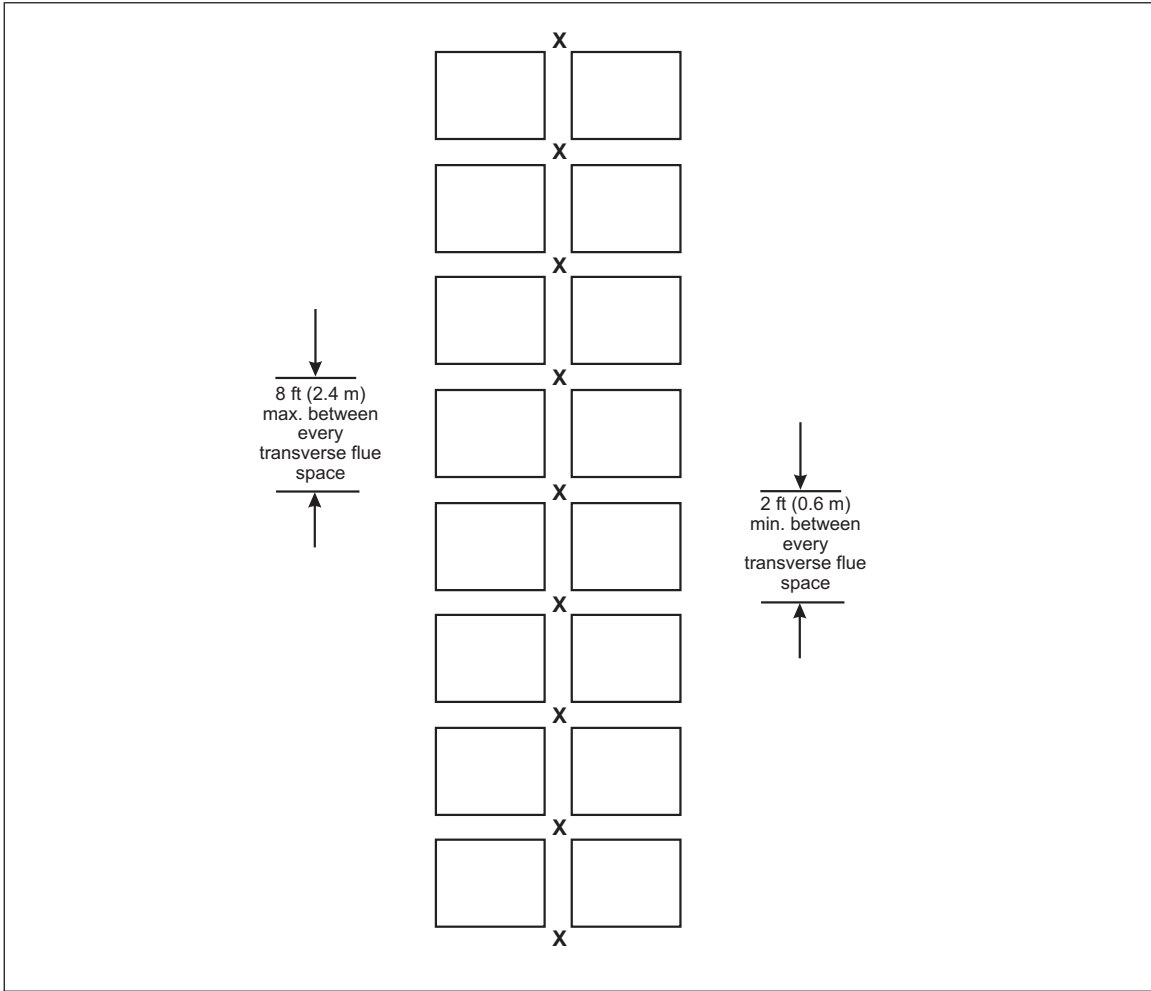

Fig. 12. Plan view of IRAS(E) in-rack sprinkler arrangement in longitudinal flue only for double-row racks

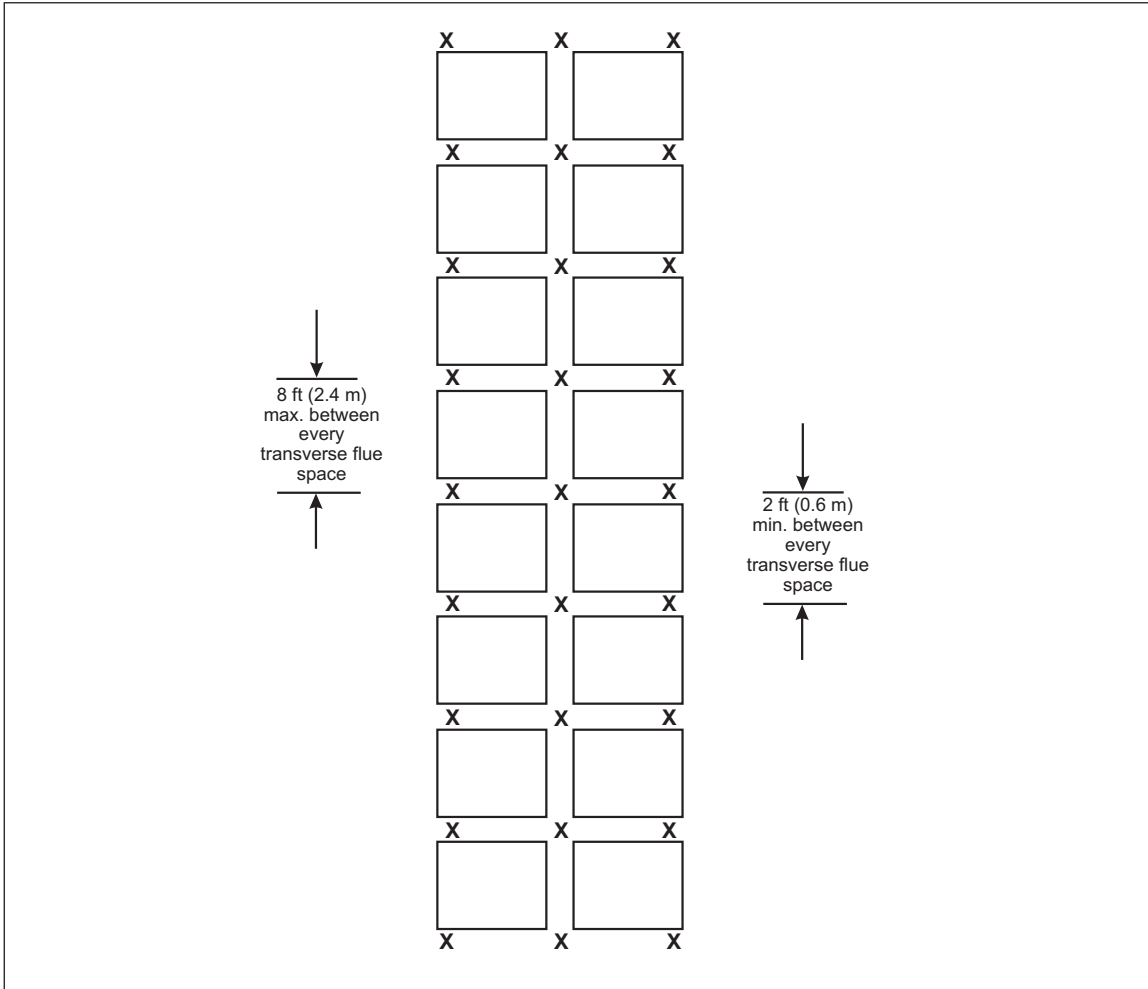

Fig. 13. Plan view of IRAS(E) in-rack sprinkler arrangement for double-row racks

8-9 Storage of Class 1, 2, 3, 4 and Plastic Commodities

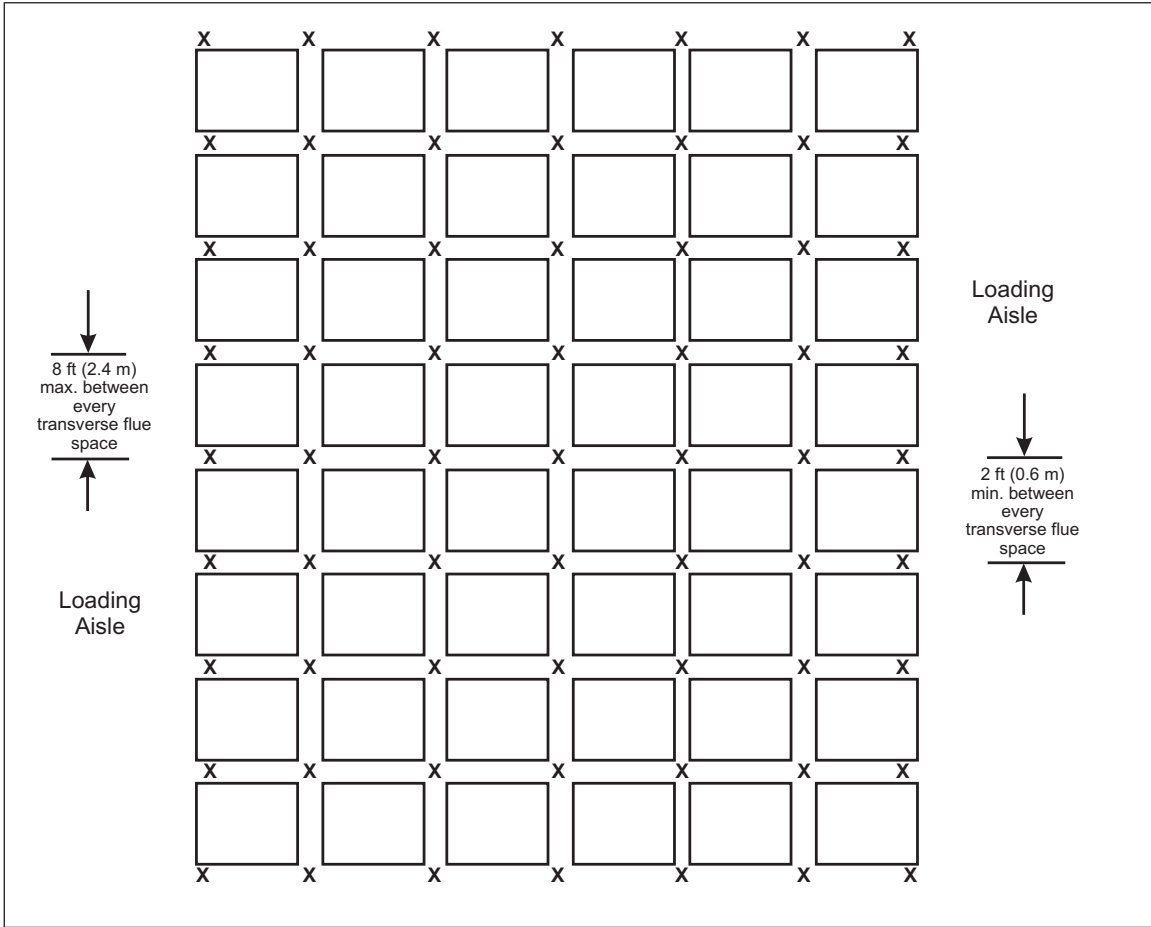

Fig. 14. Plan view of IRAS(E) in-rack sprinkler arrangement for multiple-row racks

2.3.4.6.3 Horizontal Lay-Outs for In-Rack Sprinklers in Combination With Horizontal Barriers

The use of a horizontal barrier generally reduces the number of in-rack sprinklers required per level; however, it does not reduce the number of in-rack levels required.

2.3.4.6.3.1 Use the following figures when installing horizontal barriers in combination with in-rack sprinklers:

- Figure 8: Single-row racks that (1) contain storage in closed-top containers, and (2) have a minimum 6 in. (150 mm) vertical clearance between the deflector of the in-rack sprinkler and the top of storage.
- Figure 9: Double-row racks that (1) contain storage in closed-top containers, and (2) have a minimum 6 in. (150 mm) vertical clearance between the deflector of the in-rack sprinkler and the top of storage.
- Figure 10: All multiple-row racks arrangements except as restricted per Section 2.2.5.1 for open-top containers..
- Figure 11: Single-row racks that (1) contain open-top combustible containers or (2) do not have a minimum 6 in. (150 mm) vertical clearance between the deflector of the in-rack sprinkler and the top of storage. Note that for these two given conditions, there is no difference in the horizontal in-rack sprinkler arrangement between racks equipped with horizontal barriers and those that are not.
- Figure 12: Double-row racks that do not have a minimum 6 in. (150 mm) vertical clearance between the deflector of the in-rack sprinkler and the top of closed-top container storage.
- Figure 13: Double-row racks that contain open-top combustible containers, except as modified per Section 2.2.5.1. Note that for this given condition, there is no difference in the horizontal in-rack sprinkler arrangement between racks equipped with horizontal barriers and those that are not.
- Figure 14: Multiple-row racks that contain open-top combustible containers, except as modified per Section 2.2.5.1. Note that for this given condition, there is no difference in the horizontal in-rack sprinkler arrangement between racks equipped with horizontal barriers and those that are not.

2.3.4.6.3.2 When installed in combination with a horizontal barrier, in-rack sprinklers do not have to be positioned relative to the proximity of the transverse flue spaces unless (1) there is less than 6 in. (150 mm) clearance between the top of storage and deflector of the in-rack sprinkler, or (2) the hazard of open-top containers is present within the storage rack.

2.3.4.6.3.3 If open-top noncombustible containers are present in either single-row or double-row racks, and they meet one of the conditions outlined in Section 2.2.5.1.1, the in-rack sprinkler arrangement shown in either Figure 8 or 9 can be used as long as a minimum 6 in. (150 mm) vertical clearance is provided between the in-rack sprinkler deflector and the top of storage. Otherwise, the in-rack arrangement in either Figure 11 or 12 is needed when open-top noncombustible containers are present.

2.3.4.6.3.4 Arrange loads being stored within the racks so they do not extend more than 3 in. (75 mm) beyond the edge of the horizontal barrier.

2.3.4.6.3.5 When loads being stored within the racks will extend more than 3 in. (75 mm) beyond the edge of the horizontal barrier, use a horizontal in-rack sprinkler arrangement that includes face sprinklers.

2.3.4.7 Vertical Increments of In-Rack Sprinklers

The maximum vertical increments at which in-rack sprinklers can be installed are dependent mainly on commodity hazard and, if present, the size of solid shelves.

Note that in addition to the maximum vertical increments described below, the storage height above the top level of in-rack sprinklers must be limited to a maximum of 10 ft (3.0 m) unless indicated otherwise in this data sheet.

See Figure 15 for a flowchart summarizing the recommended vertical increments for in-rack sprinklers.

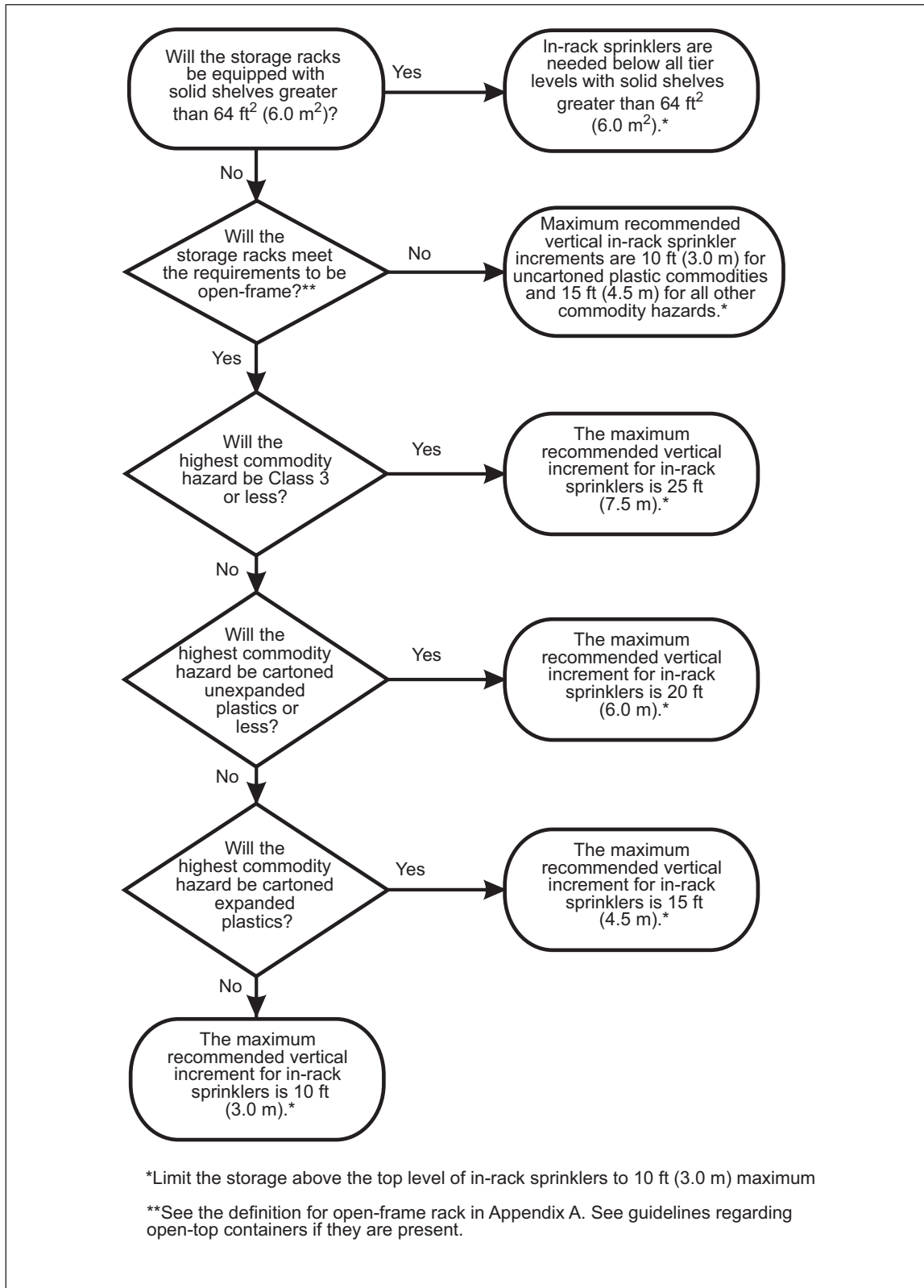

Fig. 15. Recommended vertical in-rack sprinkler increments

2.3.4.7.1 Vertical Increments of In-Rack Sprinklers in Open-Frame Racks

Unless indicated otherwise in this data sheet, limit the height of storage above the top level of in-rack sprinklers to a maximum of 10 ft (3.0 m).

2.3.4.7.1.1 When in-rack sprinklers are needed to supplement ceiling-level sprinklers in open-frame storage racks, the following maximum vertical increments can be used, based on commodity hazard:

- Class 1 – 3 Commodities: 25 ft (7.5 m)
- Class 4 and Cartoned Unexpanded Plastics: 20 ft (6.0 m)
- Cartoned Expanded Plastics: 15 ft (4.5 m)
- Uncartoned Plastics: 10 ft (3.0 m)

2.3.4.7.1.2 These maximum vertical increments can be applied to the horizontal in-rack sprinkler layouts indicated in Figures 8 through 11 as well as Figures 13 and 14; however, they do not apply to the horizontal in-rack sprinkler layout shown in Figure 12 when the ceiling height exceeds 30 ft (9.0 m). See Section 2.3.6 for possible exceptions when the ceiling height exceeds 30 ft (9.0 m) high.

2.3.4.7.2 Vertical Increments of In-Rack Sprinklers in Racks Having Solid Shelves 20 to 64 ft² (2.0 to 6.0 m²) in Area

When in-rack sprinklers are needed to supplement ceiling-level sprinklers in storage racks equipped with solid shelves 20 to 64 ft² (2.0 to 6.0 m²) in area, the following maximum vertical increments can be used, based on commodity hazard:

- Class 1 – 4 and Cartoned Plastic Commodities: 15 ft (4.5 m)
- Uncartoned Plastics: 10 ft (3.0 m)

2.3.4.7.3 Vertical Increments of In-Rack Sprinklers in Racks Having Solid Shelves Greater than 64 ft² (6.0 m²) in Area

When in-rack sprinklers are needed to supplement ceiling-level sprinklers in storage racks equipped with solid shelves greater than 64 ft² (6.0 m²) in area, in-rack sprinklers are needed directly under every tier level where these types of shelves are provided.

2.3.4.8 Design Guidelines for Ceiling-Level and In-Rack Sprinklers

The design guidelines for in-rack sprinklers are dependent on the commodity being protected, the number of in-rack sprinkler levels installed, and the height of storage above the top level of in-rack sprinklers.

The design guidelines for ceiling-level sprinklers that are supplemented with in-rack sprinklers are dependent on the commodity being protected, the horizontal in-rack sprinkler layout provided, and the height of storage above the top level of in-rack sprinklers.

2.3.4.8.1 Design Guidelines for In-Rack Sprinklers

2.3.4.8.1.1 Design in-rack sprinkler systems per in Table 12.

2.3.4.8.1.2 Balance the in-rack sprinkler system water demand with the ceiling-level sprinkler water demand at the point where the two systems are connected.

2.3.4.8.1.3 Unless indicated otherwise, ensure the minimum operating pressure of the in-rack sprinklers is 7 psi (0.5 bar).

Table 12. Hydraulic Design for In-Rack Sprinkler Systems

Commodity Hazard	Storage Height Above Top Level of IRAS, ft (m)	No. of Installed IRAS Levels	IRAS Design, No. of Sprinklers	IRAS Design, Min. Flow per Sprinkler, gpm (L/min)
Class 1-3	≤ 10 (3.0)	1	6	22 (85)
		2 or more	10 (5 on 2 levels)	22 (85)
Class 4 and Plastics	≤ 10 (3.0)	1	8	30 (115)
		2 or more	14 (7 on 2 levels)	30 (115)

8-9 Storage of Class 1, 2, 3, 4 and Plastic Commodities

2.3.4.8.1.4 Unless indicated otherwise in this data sheet, the maximum water delivery time for any dry-type in-rack sprinkler system is 60 seconds and is based on the operation of the hydraulically most remote in-rack sprinkler.

2.3.4.8.2 Design Guidelines for Ceiling-Level Sprinklers in Combination with In-Rack Sprinklers

2.3.4.8.2.1 When storage racks are protected with in-rack sprinklers in accordance with Section 2.3.4, obtain the applicable ceiling sprinkler system design using Table 13. Determine both (1) the applicable protection table (Tables 7, 8 or 10), and (2) the applicable ceiling height to use within the indicated protection table. Note that the protection table indicated by Table 13 may **not** be specific to the commodity hazard being protected.

Table 13. Determining Applicable Protection Table and Ceiling Height for Ceiling Sprinkler Designs when Ceiling-Level Sprinkler Systems are Supplemented with In-Rack Sprinklers

Commodity Hazard	IRAS Arrangement	Maximum Storage Height Above Top IRAS Level, ft (m)	Maximum Clearance Between Top of Storage and Ceiling, ft (m)*	Applicable Ceiling-Level Sprinkler Protection Table	Ceiling Height in Applicable Protection Table, ft (m)
Class 1, 2 and 3	IRAS(EO)	5 (1.5)	5 (1.5)	7	10 (3.0)
			20 (6.0)	7	20 (6.0)
		10 (3.0)	20 (6.0)	7	20 (6.0)
	IRAS(E)	5 (1.5)	10 (3.0)	7	10 (3.0)
			20 (6.0)	7	20 (6.0)
		10 (3.0)	20 (6.0)	7	20 (6.0)
Class 4, Cartoned Unexpanded Plastics and Cartoned Expanded Plastics	IRAS (EO)	5 (1.5)	5 (1.5)	8	10 (3.0)
			20 (6.0)	8	15 (4.5)
		10 (3.0)	15 (4.5)	8	15 (4.5)
	IRAS (E)	5 (1.5)	10 (3.0)	8	10 (3.0)
			20 (6.0)	8	15 (4.5)
		10 (3.0)	20 (6.0)	8	15 (4.5)
Uncartoned Unexpanded Plastics and Uncartoned Expanded Plastics	IRAS (EO)	5 (1.5)	5 (1.5)	8	10 (3.0)
			20 (6.0)	8	15 (4.5)
		10 (3.0)	5 (1.5)	8	15 (4.5)
	15 (4.5)		10	15 (4.5)	
	20 (6.0)		10	20 (6.0)	
	IRAS (E)	5 (1.5)	5 (1.5)	8	10 (3.0)
			20 (6.0)	8	15 (4.5)
		10 (3.0)	5 (1.5)	8	15 (4.5)
			10 (3.0)	8	20 (6.0)
15 (4.5)			10	15 (4.5)	
20 (6.0)			10	20 (6.0)	

* When this distance is greater than 20 ft (6.0 m), see Section 2.3.3.7.3 for guidance.

2.3.4.8.2.2 Use the ceiling height indicated for an IRAS(E) arrangement when in-rack sprinklers are used in combination with horizontal barriers or when in-rack sprinklers are installed under solid shelves.

2.3.4.8.2.3 Balance the ceiling-level sprinkler system water demand with the in-rack sprinkler system water demand at the point where the two systems are connected.

2.3.4.9 Design Guidelines for Fire Protection Scheme 8-9A

See Appendix A, Fire Protection Scheme 8-9A, for a description of the intent of this protection arrangement as well as an example of its use.

2.3.4.9.1 Dedicated Storage Rack

Establish a dedicated storage rack (or racks) where all of the high-challenge commodities will be maintained. If this storage rack will not be solely dedicated to the storage of high-challenge commodities then either (1) extend the Fire Protection Scheme 8-9A (i.e. Scheme 8-9A) protection horizontally one pallet load in all directions beyond the designated high-challenge commodities storage area, or (2) install a vertical barrier to segregate the high-challenge commodities from any adjacent commodities.

Commodities that can be protected by the ceiling-level sprinkler system can be stored vertically above as well as horizontally adjacent to the portions of the storage rack equipped with Scheme 8-9A protection.

2.3.4.9.2 Horizontal Barriers

Install horizontal barriers (see Appendix A for a definition of horizontal barriers) at every tier level of the dedicated storage rack if the rack is equipped with solid shelves. If the dedicated storage rack is open-frame (see Appendix A for a definition of open-frame rack storage) install horizontal barriers at vertical increments not exceeding 12 ft (3.6 m). Span the barriers horizontally so that all flue spaces within the rack bay are covered. A maximum 3 in. (75 mm) wide gap is acceptable at rack uprights.

2.3.4.9.3 In-Rack Sprinklers

Install minimum K8.0 (K115) FM Approved, quick-response sprinklers fed only by a wet sprinkler system beneath each horizontal barrier. Locate the thermal element of the in-rack sprinkler no more than 9 in. (225 mm) vertically below the underside of the horizontal barrier.

For single-row racks, install sprinklers at each rack upright as well as at each rack mid-bay as shown in Figure 16. The maximum linear spacing between sprinklers is 5 ft (1.5 m).

For double-row racks, install sprinklers at each rack upright within the longitudinal flue space as well as at the face of the rack. In addition, install sprinklers at the mid-bay face of each rack bay as shown in Figure 17. The maximum linear spacing between sprinklers is 5 ft (1.5 m) at the rack face and 10 ft (3.0 m) within the longitudinal flue space.

For multiple-row racks, install an alternating IRAS(E)/IRAS(EO) sprinkler arrangement within adjacent transverse flue spaces as shown in Figure 18. Note that sprinklers are needed at the face of each flue space. The maximum linear spacing between sprinklers using an IRAS(E) sprinkler arrangement is 5 ft (1.5 m) and 10 ft (3.0 m) between sprinklers using an IRAS(EO) sprinkler arrangement.

Base the design the in-rack sprinkler system on a minimum flow of 60 gpm (230 L/min) from the most remote 6 sprinklers for single-row racks or the most remote 8 sprinklers for both double-row and multiple-row racks. Include a hose demand allowance of 250 gpm (950 L/min) for manual intervention. Provide the combined water demand (in-rack and hose demand) for at least one hour. Note that the in-rack sprinkler demand (1) does not have to be hydraulically balanced with the ceiling-level sprinkler system, and (2) does not have to be accounted for operating simultaneously with the ceiling-level sprinkler system.

2.3.4.9.4 Ceiling Sprinkler System

Design the ceiling-level sprinkler system as outlined in this data sheet based on the highest commodity hazard not protected by the Scheme 8-9A protection. The sprinkler demand for Scheme 8-9A does not have to be hydraulically balanced with the ceiling-level sprinkler system nor does it have to be considered operating simultaneously with it either.

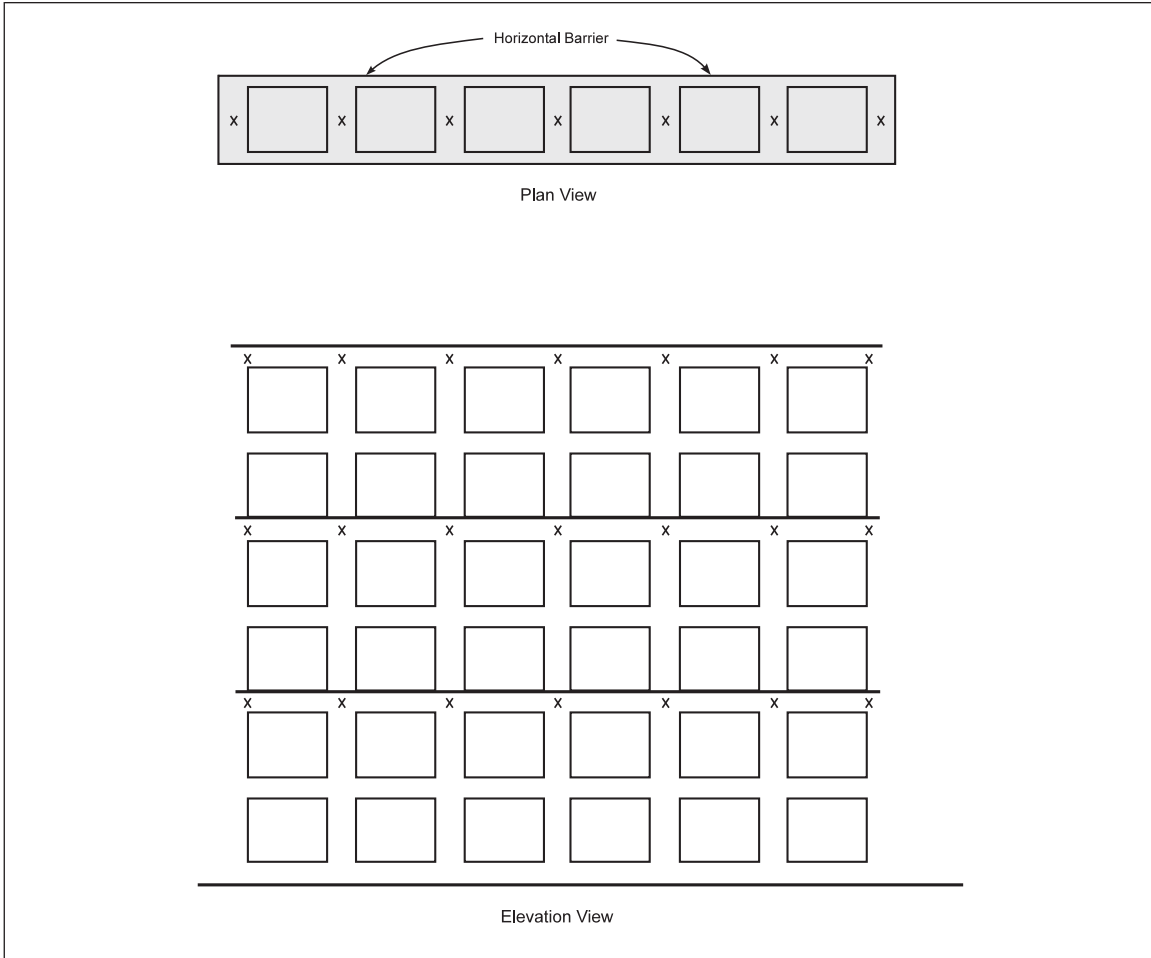

Fig. 16. Fire Protection Scheme 8-9A within single-row racks

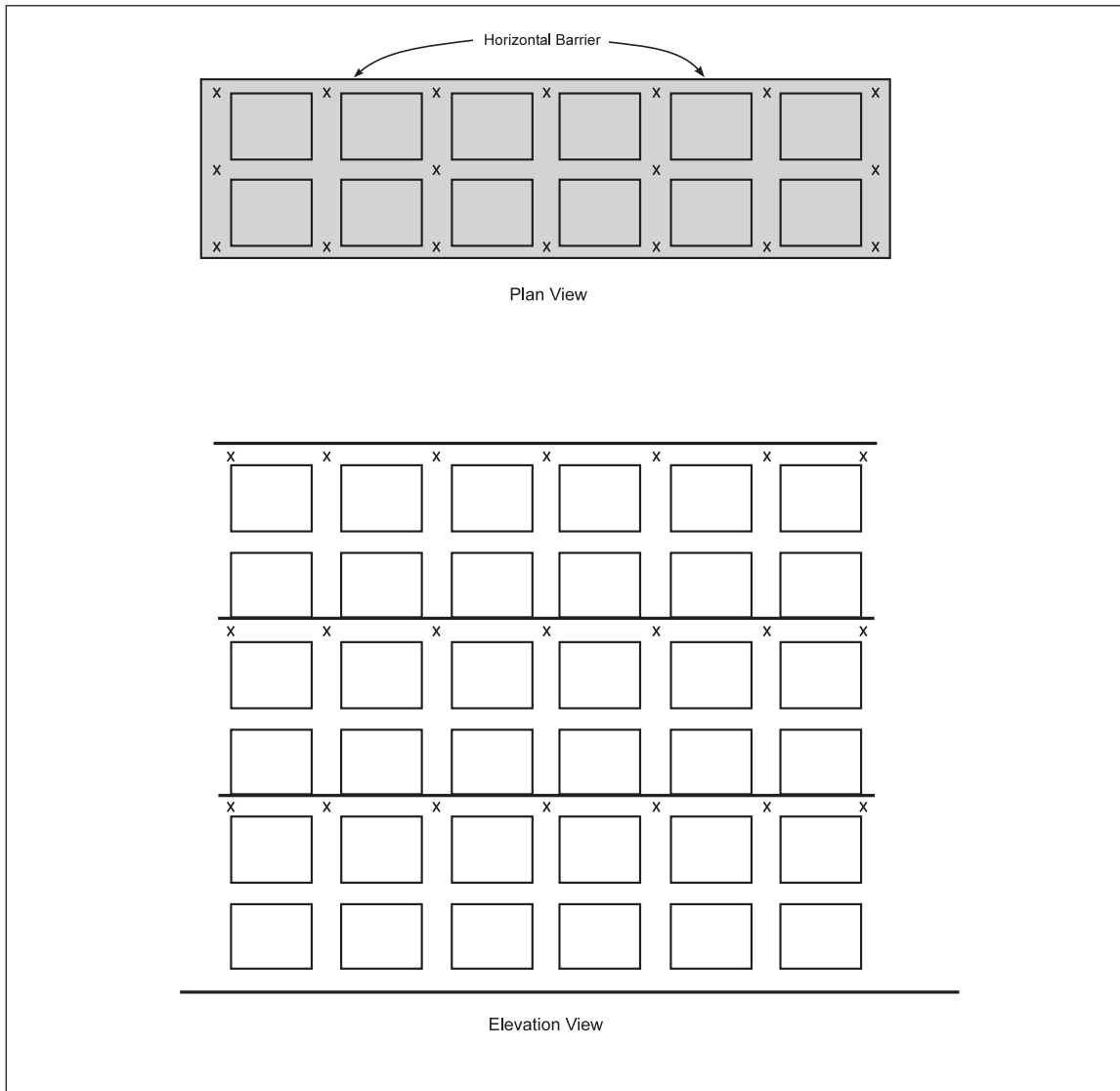

Fig. 17. Fire Protection Scheme 8-9A within double-row racks

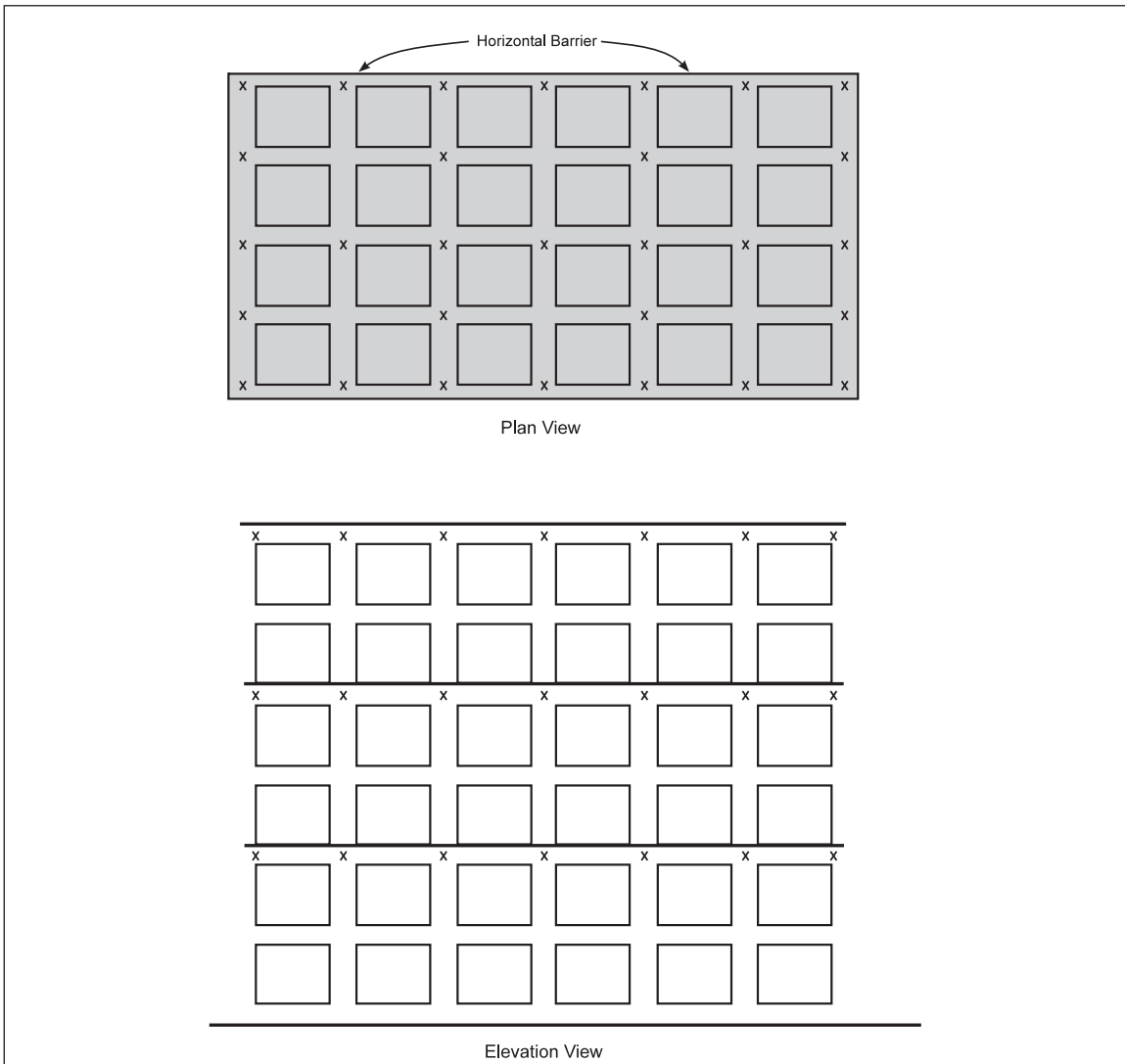

Fig. 18. Fire Protection Scheme 8-9A within multiple-row racks

2.3.5 Hose Demands, Hose Connections, and System Duration

2.3.5.1 Hose Demand and System Duration

2.3.5.1.1 See Table 14 to determine the recommended hose demand for system design purposes that account for potential manual intervention. Allow at least 100 gpm (380 L/min) for inside hose stream usage, when provided, and add the balance of the hose demand to the overall sprinkler demand at the point of connection.

2.3.5.1.2 In addition, ensure the water supplies are capable of providing the combined sprinkler system (ceiling and, if provided, in-rack) and hose demands at adequate pressure per the duration guidelines in Table 14.

Table 14. Hose Demand and Water Supply Duration Design Guidelines

Sprinkler Type by Spacing	No. of Sprinklers in Ceiling Design	Hose Demand, gpm (L/ min)	Duration, min
Standard-coverage	Up to 12	250 (950)	60
	13 to 19	500 (1,900)	90
	20 or more	500 (1,900)	120
Extended-coverage	Up to 6	250 (950)	60
	^a 7 to 9	500 (1,900)	90
	10 or more	500 (1,900)	120

^a When the maximum linear spacing is 12 ft (3.7 m), the hose demand can be 250 gpm (950 L/min) and the duration can be 60 minutes.

2.3.5.2 Hose Connections

Provide permanent small hose lines (1-1/2 in. [40 mm]) not exceeding 100 ft (30 m) in length, capable of reaching all storage areas to aid in potential initial-stage firefighting as well as for after-extinguishment mop-up operations. Supply small hose lines from any of the following:

- a. A separate piping system for small hose stations, or
- b. Valved hose connections on sprinkler risers where such connections are made upstream from all sprinkler control valves, or
- c. Adjacent sprinkler systems, or
- d. Ceiling sprinklers in the protected area when separately controlled in-rack sprinklers are provided

It may be preferable from an operations standpoint to locate hose stations on the ends of racks or storage piles rather than in aisles.

In freezers, or other areas subject to freezing, consider the number, location, and arrangement of hose stations.

2.3.6 Special Applications

2.3.6.1 Ceiling-Only Sprinkler Protection for Class 1, 2 and 3 Commodities Protected by Dry-Pipe and Similar Sprinkler Systems for Ceiling Heights Over 30 ft (9.0 m)

In addition to the protection design guidelines in Tables 2 and 7 for the protection of Class 1, 2, and 3 commodities by ceiling-level sprinklers on dry-pipe and similar sprinkler systems in storage areas having a maximum ceiling height of 30 ft (9.0 m) in Table 2 and 7, ceiling-level protection without the need for in-rack sprinklers is also available for these commodities for ceiling heights over 30 ft (9.0 m) and up to 55 ft (16.5 m) high in accordance with this section.

2.3.6.1.1 Acceptable storage arrangements include solid-piled, palletized, shelf, bin-box, and open-framed racks. Note that push-back type flow-through racks do not qualify as open frame racks for this protection guidance.

2.3.6.1.2 Use FM Approved, upright, standard-response ceiling-level Storage sprinklers having a nominal temperature rating of 280°F (140°C) on a tree-type dry-pipe or similar sprinkler system. Dry-pipe, non-interlocked pre-action and single-interlock pre-action sprinkler systems are acceptable for ambient temperatures that will not drop below 16°F (-9°C). For ambient temperatures that can drop below 16°F (-9°C) install sprinklers only on a refrigerated area sprinkler system that is in accordance with both Data Sheet 2-0, *Installation Guidelines for Automatic Sprinklers*, and Data Sheet 8-29, *Refrigerated Storage*.

2.3.6.1.3 If sprinkler protection will be installed using non-interlocked pre-action, single-interlocked pre-action or refrigerated-area sprinkler systems, follow the guidelines outlined in Data Sheet 5-48, *Automatic Fire Detection*, and Data Sheet 8-29, *Refrigerated Storage*, regarding the proper installation of the detection system that will be used for releasing the pre-action valve.

2.3.6.1.4 See Table 14a to determine the available ceiling-level sprinkler system design options for Class 1 and 2 commodities or Table 14b for Class 3 commodities.

8-9 Storage of Class 1, 2, 3, 4 and Plastic Commodities

Table 14a. Ceiling-Level Sprinkler System Designs for Class 1 and 2 Commodities Protected by Dry-Pipe and Similar Sprinkler Systems

Max. Ceiling Height, ft (m)	Storage Arrangement	Ceiling-Level Sprinkler	Min. Rack Aisle Width, ft (m)	Sprinkler System Design, No. of AS @ Min. Pressure, psi (bar)	Max. Water Delivery Time	Hose Demand, gpm (L/min)	System Duration, minutes
35 (10.5)	Solid Piled, Palletized, Shelf, Bin-Box	K11.2 (K160)	DNA	20 @ 25 (1.7)	40	500 (1900)	120
		K16.8 (K240)	DNA	20 @ 10 (0.7)			
		K25.2 (K360)	DNA	20 @ 7 (0.5)			
		K33.6 (K480)	DNA	20 @ 50 (3.5)			
40 (12.0)	Solid Piled, Palletized, Shelf, Bin-Box and Open-Frame Racks*	K11.2 (K160)	8 (2.4)	36 @ 55 (3.8)	30	500 (1900)	120
		K16.8 (K240)	8 (2.4)	36 @ 22 (1.5)	30	500 (1900)	120
		K25.2 (K360)	4 (1.2)	24 @ 15 (1.0)	25	500 (1900)	120
			6 (1.8)	12 @ 50 (3.5)	20	500 (1900)	90
		K33.6 (K480)	6 (1.8)	12 @ 50 (3.5)	20	500 (1900)	90
45 (13.5)	Solid Piled, Palletized, Shelf, Bin-Box and Open-Frame Racks*	K25.2 (K360)	6 (1.8)	12 @ 50 (3.5)	20	500 (1900)	90
		K33.6 (K480)	6 (1.8)	12 @ 50 (3.5)	20	500 (1900)	90
50 (15.0)	Solid Piled, Palletized, Shelf, Bin-Box and Open-Frame Racks*	K33.6 (K480)	8 (2.4)	15 @ 50 (3.5)	20	500 (1900)	90
55 (16.5)	Solid Piled, Palletized, Shelf, Bin-Box and Open-Frame Racks*	K33.6 (K480)	8 (2.4)	16 @ 50 (3.5)	20	500 (1900)	120

* See the definition of Open-Frame Rack Storage in Appendix A to confirm that any multiple-row racks being protected in accordance with this table meet the requirements to be considered open-frame.

Storage of Class 1, 2, 3, 4 and Plastic Commodities 8-9

Table 14b. Ceiling-Level Sprinkler System Designs for Class 3 Commodities Protected by Dry-Pipe and Similar Sprinkler Systems

Max. Ceiling Height, ft (m)	Storage Arrangement	Ceiling-Level Sprinkler	Min. Rack Aisle Width, ft (m)	Sprinkler System Design, No. of AS @ Min. Pressure, psi (bar)	Max. Water Delivery Time	Hose Demand, gpm (L/min)	System Duration, minutes
35 (10.5)	Solid Piled, Palletized, Shelf, Bin-Box	K11.2 (K160)	DNA	20 @ 25 (1.7)	40	500 (1900)	120
		K16.8 (K240)	DNA	20 @ 10 (0.7)			
		K25.2 (K360)	DNA	20 @ 7 (0.5)			
		K33.6 (K480)	DNA	20 @ 50 (3.5)			
40 (12.0)	Solid Piled, Palletized, Shelf, Bin-Box and Open-Frame Racks*	K25.2 (K360)	4 (1.2)	24 @ 15 (1.0)	25	500 (1900)	120
			6 (1.8)	12 @ 50 (3.5)	20	500 (1900)	90
		K33.6 (K480)	8 (2.4)	15 @ 50 (3.5)	20	500 (1900)	90
45 (13.5)	Solid Piled, Palletized, Shelf, Bin-Box and Open-Frame Racks*	K25.2 (K360)	6 (1.8)	12 @ 50 (3.5)	20	500 (1900)	90
		K33.6 (480)	6 (1.8)	12 @ 50 (3.5)	20	500(1900)	90
50 (15.0)	Solid Piled, Palletized, Shelf, Bin-Box and Open-Frame Racks*	K33.6 (K480)	8 (2.4)	15 @ 50 (3.5)	20	500 (1900)	90
55 (16.5)	Solid Piled, Palletized, Shelf, Bin-Box and Open-Frame Racks*	K33.6 (K480)	8 (2.4)	16 @ 50 (3.5)	20	500 (1900)	120

* See the definition of Open-Frame Rack Storage in Appendix A to confirm that any multiple-row racks being protected in accordance with this table meet the requirements to be considered open-frame.

See Section 2.3.2.5 to determine how many open remote ceiling-level sprinklers to use for the purpose of calculating the maximum water delivery time.

2.3.6.1.5 To achieve the maximum water delivery time indicated above in Tables 14a and 14b, experience to date has demonstrated that the size of the sprinkler system will need to be limited to approximately 12,000 ft² (1,110 m²). Validate the maximum water delivery time before the start of any work by submitting copies of all plans, calculations, water supply details, and equipment details to the local FM Global service office for computer analysis. Specific details needed for this evaluation include:

- a) Manufacturer and model designation for the dry-pipe or pre-action valve
- b) Manufacturer and model designation for the dry-pilot actuator, as well as response characteristics, including performance criteria that relates actuation time to air pressure setting and static water pressure
- c) Air pressure to be maintained within the sprinkler piping

Note that all FM Approved pre-action and refrigerated-area sprinkler systems must be provided with all trim and accessories included as part of the Approval package. Contact the local FM Global service office before sending the information.

2.3.6.1.6 Handle all other plan review details through normal procedures as described in Data Sheet 2-0, *Installation Guidelines for Automatic Sprinklers*.

2.3.6.2 Retail/Big-Box Warehouse Occupancies

Retail/big-box warehouse occupancies typically have full or partial pallet loads in the top tiers of the racks. These pallet loads are broken down as needed to replenish individual stock items in the lower tiers. Lower tiers have slatted or solid shelving, while upper tiers may have slatted, wire mesh, or open shelving. Rack arrangements with certain combinations of slatted, wire mesh, or open shelves that do not qualify as rack storage with open shelves as described in Appendix A can nevertheless be protected as rack storage with open shelves if they meet the conditions described in Sections 2.3.6.2.1 and 2.3.6.2.2.

2.3.6.2.1. Protect rack storage up to 20 ft (6.0 m) high as rack storage with open shelves when all of the following conditions are met:

- a) Slatted shelves are provided, they are fixed-in-place and provide a minimum 3 in. (75 mm) wide transverse flue space, and
- b) There are no solid shelf levels above the 12 ft (3.6 m) height in the rack (although there may be other open shelf or wire mesh shelf levels above), and
- c) Transverse flue spaces are a minimum 3 in. (75 mm) wide and are provided no more than 10 ft (3.0 m) apart horizontally, and
- d) The storage commodity does not consist of uncartoned plastics.

2.3.6.2.2. Provide longitudinal flue spaces if slatted shelf openings and transverse flue spaces do not run completely through the racks.

2.3.6.2.3. If the stored commodities include aerosols or flammable or combustible liquids, adhere to the recommendations in the relevant occupancy-related data sheet.

2.3.6.3 Protection of Class 1, 2, 3, 4 and Cartoned Plastics in Open-Frame Single and Double-Row Racks Using In-Rack Sprinklers Only in the Longitudinal Flue Space

2.3.6.3.1 Class 1, 2, 3, 4 and cartoned plastic commodities maintained in single-row and double-row racks can be protected by in-rack sprinklers in only the longitudinal flue space under the following conditions:

- The ceiling and in-rack sprinkler systems are wet-pipe only, and
- The storage racks meet the definition of open-frame, and
- The depth (aisle-to-aisle) of the double-racks does not exceed 9 ft (2.7 m), and
- The in-racks sprinklers are in accordance with Sections 2.3.4.1.1, 2.3.4.3, 2.3.4.4, and 2.3.4.5, and
- The in-rack sprinklers are installed horizontally at every transverse flue space intersection as outlined in Figure 11 for single-row racks and Figure 12 for double-row racks, and

- The in-rack sprinklers are installed on vertical increments not exceeding 12 ft (3.6 m), and
- The storage height above the top in-rack sprinkler level does not exceed 10 ft (3.0 m), and
- The in-rack design is based on Table 12, and
- The ceiling design is based on Table 13, and
- The hose stream allowance and system duration are based on Table 14.

2.3.6.3.2 As an alternative to the protection outlined in Section 2.3.6.3.1, Class 1, 2, 3, 4 and cartoned plastic commodities maintained in single-row and double-row racks can also be protected by in-rack sprinklers in only the longitudinal flue space under the following conditions:

- The ceiling and in-rack sprinkler systems are wet-pipe only, and
- The storage racks meet the definition of open-frame, and
- The depth (aisle-to-aisle) of the double-row racks does not exceed 9 ft (2.7 m), and
- The in-rack sprinklers are quick-response and in accordance with Sections 2.3.4.1.1, 2.3.4.3, 2.3.4.4, and 2.3.4.5, and
- The in-rack sprinklers are installed horizontally at every other transverse flue space intersection, as outlined in Figure 8 for single-row racks and Figure 9 for double-row racks, and staggered vertically, and
- The in-rack sprinklers are installed on vertical increments not exceeding 12 ft (3.6 m), and
- All transverse/longitudinal flue space intersections are protected with in-rack sprinklers at vertical increments not exceeding 24 ft (7.2 m), and
- The storage height above the top in-rack sprinkler level does not exceed 10 ft (3.0 m), and
- The in-rack design is based on Table 12, and
- The ceiling design is based on Table 13, and
- The hose stream allowance and system duration are based on Table 14.

2.3.6.4 Protection of Class 1, 2, 3, 4, Cartoned Plastics and Uncartoned Unexpanded Plastics in Single and Double-Row Racks Using a Combination of Longitudinal In-Rack Sprinklers and Horizontal Barriers

Class 1, 2, 3, 4, cartoned plastic and uncartoned unexpanded plastic commodities maintained in single-row and double-row racks can be protected by in-rack sprinklers in only the longitudinal flue space under the following conditions:

- The storage racks are not physically equipped with solid shelves, and
- **The stored products within the racks do not extend more than 3 in. (75 mm) beyond the edge of the horizontal barrier, and**
- A minimum gross 3 in. (75 mm) wide space is provided between stored product, and
- A minimum net 3 in. (75 mm) wide space is provided horizontally at least every 10 ft (3.0 m), and
- The depth (aisle-to-aisle) of the double-row racks does not exceed 9 ft (2.7 m), and
- The in-rack sprinklers are quick-response and in accordance with Sections 2.3.4.1.1, 2.3.4.3, 2.3.4.4, and 2.3.4.5, and
- The longitudinal in-rack sprinklers are installed horizontally on a maximum linear spacing of 5 ft (1.5 m), and
- The in-rack sprinklers are installed on vertical increments not exceeding 12 ft (3.6 m), and
- The horizontal barriers are installed above the lowest in-rack sprinkler level as well as vertically at every other in-rack sprinkler level (i.e., first in-rack level, third in-rack level, etc.), and
- The storage height above the top in-rack sprinkler level does not exceed 10 ft (3.0 m), and
- The in-rack design is based on Table 12, and

- The ceiling design is based on Table 13, and
- The hose stream allowance and system duration are based on Table 14.

2.3.6.5 Protection of Class 1, 2, 3, 4 and Unexpanded (Cartoned and Uncartoned) Plastics in Open-Frame Storage Racks Using K14.0 (K200) and Larger, Quick-Response, Pendent Ceiling-level Sprinklers for Ceiling Heights up to 45 ft (13.5 m) High

Class 1, 2, 3, 4, and unexpanded plastics (cartoned and uncartoned) can be protected by a single level of in-rack sprinklers under the following conditions:

- The ceiling-level sprinkler are quick-response, standard-coverage (does not apply to extended-coverage sprinklers), and minimum K14.0 (K200) or larger, and
- The storage racks meet the definition of open-frame, and
- The in-rack sprinklers are installed on a wet system only and are in accordance with Sections 2.3.4.1.1, 2.3.4.3, 2.3.4.4, and 2.3.4.5, and
- The in-rack sprinklers are installed horizontally at every transverse flue space intersection as outlined in Figure 11 for single-row racks, Figure 12 for double-row racks and Figure 14 for multiple-row racks (face sprinklers not required in Figure 14), and
- The in-rack sprinklers are installed vertically at a tier height that is located within the range of one-half to two-thirds of the overall storage height, and
- The in-rack design is based on a minimum flow of 60 gpm (230 L/min) from the most remote 8 in-rack sprinklers, and
- The ceiling design is obtained from the protection table for the commodity hazard being protected using a ceiling height of 40 ft (12.0 m). For uncartoned unexpanded plastics being protected by either quick-response K14.0 (K200) pendent sprinklers, or quick-response K16.8 (K240) pendent sprinklers, use a ceiling design of 12 AS @ 90 psi (6.2 bar) for the K14.0 (K200) sprinkler, or a ceiling design of 12 AS @ 63 psi (4.3 bar) for the K16.8 (K240) sprinkler, and
- The hose stream allowance and system duration are based on Table 14.

2.3.6.6 Alternative In-Rack Sprinkler Designs

2.3.6.6.1 General

The in-rack sprinkler designs provided in this section are alternatives to the in-rack sprinkler designs recommended in Section 2.3.4 of this data sheet.

2.3.6.6.2 Occupancy

The designs in this section can be used to protect all commodities addressed in this data sheet.

Do not use the in-rack sprinkler designs in this section to protect open-top containers, unless they are located on the bottom tier level.

Storage racks must be considered “open-frame” as defined in Appendix A.

2.3.6.6.3 Protection

2.3.6.6.3.1 In-Rack Sprinkler System

The alternative in-rack sprinkler designs in this section are for wet-pipe systems only.

2.3.6.6.3.2 In-Rack Sprinklers

Use FM Approved Storage (ceiling) sprinklers that are standard-coverage, quick-response, pendent, and have a nominal temperature rating of 160°F (70°C). Use minimum K22.4 (K320) sprinklers; however, minimum 14.0 (K200) sprinklers can be used when the required flow for the commodity being protected is 100 gpm (380 L/min) or less.

2.3.6.6.3.3 Horizontal Location of In-Rack Sprinklers

See Figures 19a, 19b, 19c, 20a, 20b and 21 for the recommended horizontal location of in-rack sprinklers, depending on the type of storage rack being protected. The minimum and maximum horizontal distances between in-rack sprinklers is 27 in. (700 mm) and 4.5 ft (1.4 m), respectively, except as shown in the applicable figures. The maximum horizontal distance between face sprinklers and either (1) the face of the storage rack, or (2) the outer edge of the pallet load if it protrudes into the aisle, is 18 in. (450 mm). Locate all in-rack sprinklers within the footprint of the rack structure they are intended to protect. In-rack sprinklers protecting the flue space created between a single-row rack structure and a wall located within 12 in. (300 mm) horizontally of the rack structure can be positioned outside the footprint of the single-row rack structure as shown in Figure 19c.

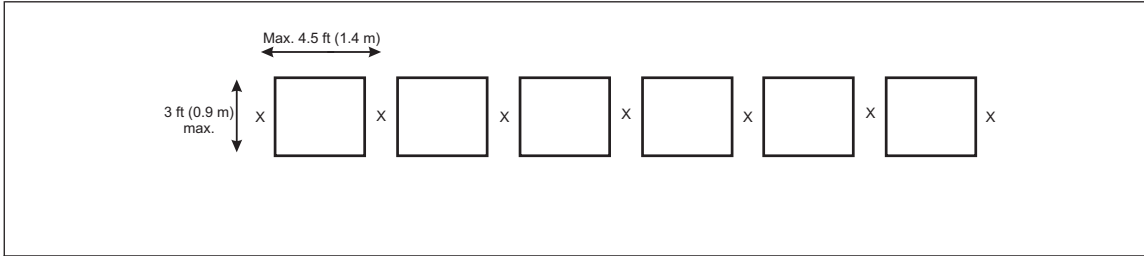

Fig. 19a. Plan view of alternative in-rack sprinkler arrangement for single-row racks up to 3 ft (0.9 m) deep

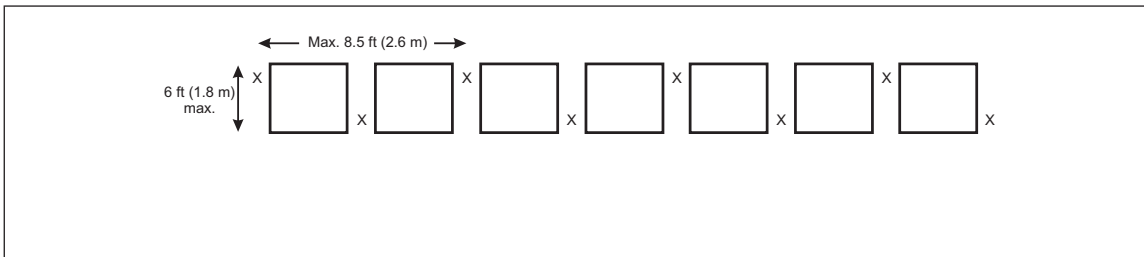

Fig. 19b. Plan view of alternative in-rack sprinkler arrangement for single-row racks up to 6 ft (1.8 m) deep

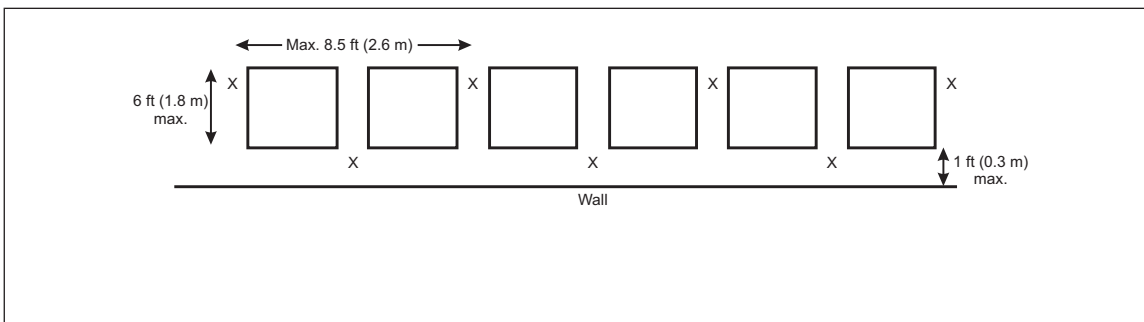

Fig. 19c. Plan view of alternative in-rack sprinkler arrangement for single-row racks up to 6 ft (1.8 m) deep located against wall

Arrange sprinkler piping and in-rack sprinklers to avoid mechanical damage, but ensure proper distribution from the in-rack sprinkler can be achieved. Prior to installing in-rack sprinklers, check the proposed in-rack sprinkler locations to ensure both adequate protection against mechanical damage and proper sprinkler discharge are provided.

2.3.6.6.3.4 Vertical Location of In-Rack Sprinklers

The maximum vertical distance between in-rack sprinkler levels is 30 ft (9.0 m) for cartoned expanded plastics as well as uncartoned plastics. The maximum vertical distance for Class 1 through 4 and cartoned unexpanded plastics is 40 ft (12 m). Provide a minimum vertical clearance of 6 in. (150 mm) between the top of storage and the sprinkler deflector.

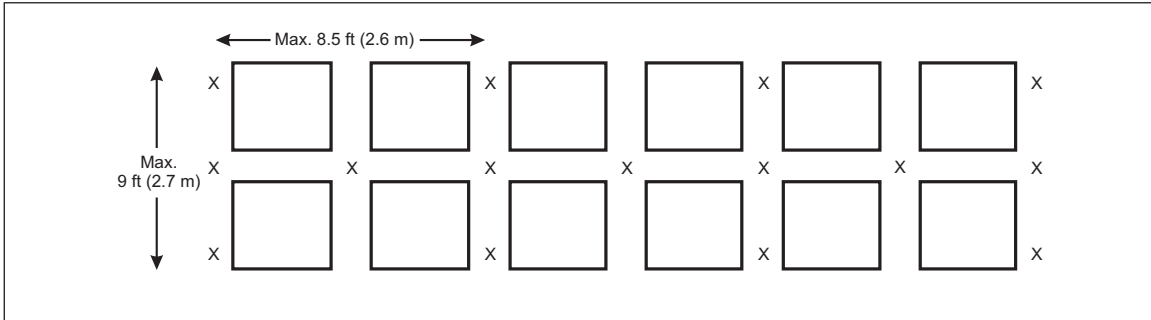

Fig. 20a. Plan view of alternative in-rack sprinkler arrangement for double-row racks up to 9 ft (2.7 m) deep

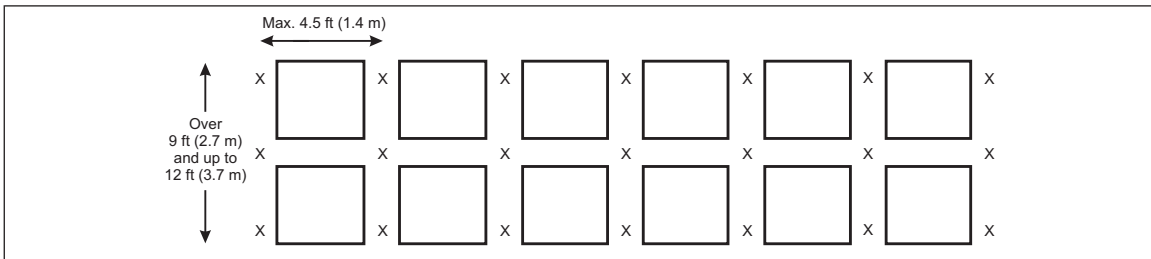

Fig. 20b. Plan view of alternative in-rack sprinkler arrangement for double-row racks up to 12 ft (3.7 m) deep

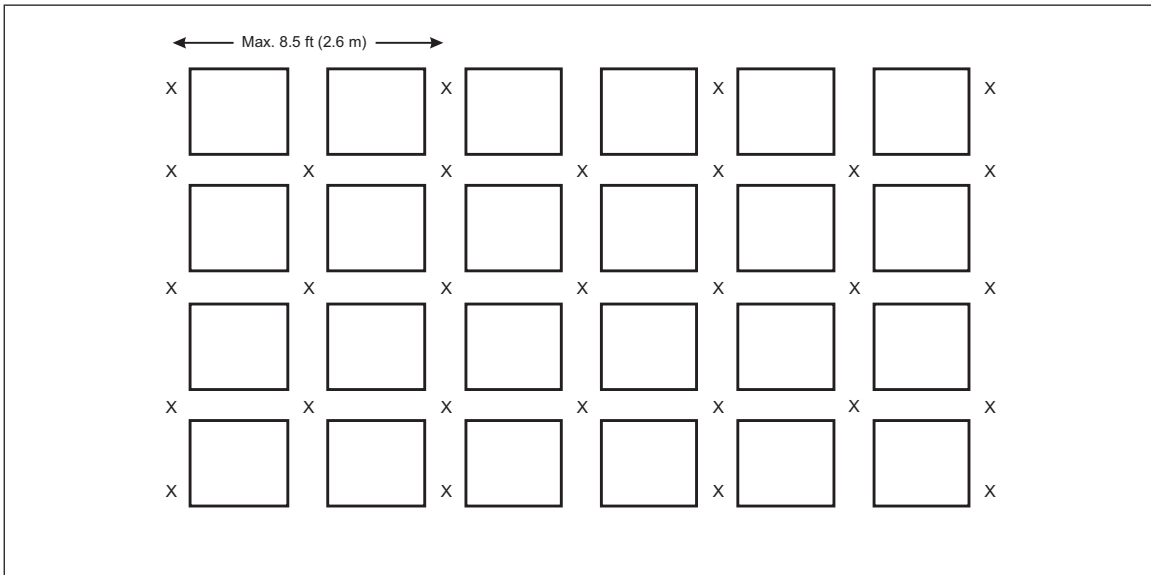

Fig. 21. Plan view of alternative in-rack sprinkler arrangement for multiple-row racks

At each tier level where in-rack sprinklers are needed, position the in-rack sprinkler deflector at or just below the bottom of the rack's horizontal support member when it is under full load conditions.

2.3.6.6.3.5 In-Rack Sprinkler System Design

Regardless of the number of in-rack sprinkler levels installed, base the in-rack sprinkler system design on the single most hydraulically remote in-rack sprinkler level. Base the minimum number of in-rack sprinklers in the system design per Table 15.

Table 15. Number of Sprinklers in the In-Rack Design

IRAS Installation Figure Used	Number of Sprinklers in the In-Rack Design	
	Class 1 through 4 and Cartoned Plastics	Uncartoned Plastics
Single-row racks up to 3 ft (0.9 m) deep (Fig. 19a)	4	4
Single-row racks up to 6 ft (1.8 m) deep (Fig. 19b)	5	5
Single-row racks up to 6 ft (1.8 m) deep against wall (Fig. 19c)	5	5
Double-row racks up to 9 ft (2.7 m) deep (Fig. 20a)	6	5 & 5*
Double-row racks up to 12 ft (3.6 m) deep (Fig. 20b)	6	5 & 5*
Multiple-row racks (Fig. 21)	6	5 & 5*

*The number of sprinklers is based on the most remote 5 in-rack sprinklers in the most remote storage rack as well as the most remote 5 in-rack sprinklers in the adjacent storage rack.

Base the minimum flow required in the system design from the most remote in-rack sprinkler per Table 16.

Table 16. Minimum Flow in the In-Rack Design

Max. Vertical IRAS Installation, ft (m)	Commodity Hazard	Min. K-factor	Min. Flow, from Most Remote In-Rack Sprinkler, gpm (L/min)
30 (9.0)	Class 1 through 4 and Cartoned Unexpanded Plastic	14.0 (200)	65 (250)
	Cartoned Expanded Plastic	14.0 (200)	100 (380)
	Uncartoned Plastics	22.4 (320)	120 (455)
40 (12)	Class 1 through 4 and Cartoned Unexpanded Plastic	22.4 (320)	120 (455)

As part of the in-rack sprinkler system design include a hose stream allowance of 250 gpm (950 L/min) for manual extinguishment. Allow at least 100 gpm (380 L/min) for inside hose stream usage, when provided, and add the balance of the hose demand to the overall in-rack sprinkler demand at the point of connection. Arrange the water supply to provide the required in-rack sprinkler system demand and hose stream allowance (when taken from the same water supply feeding the in-rack sprinkler system) for a minimum of 60 minutes.

The water supply must be capable of providing the required design for the in-rack sprinkler system independent of the design requirements of the ceiling sprinkler system. It is not necessary to hydraulically balance the in-rack sprinkler system with the ceiling-level sprinkler system, nor account for them flowing simultaneously.

2.3.6.6.3.6 Ceiling Sprinkler System Design

Design and install the ceiling-level sprinkler system in accordance with the guidelines in Section 2.3, except as modified in this section. When the in-rack sprinkler system is designed and installed in accordance with Sections 2.3.6.6.1, 2.3.6.6.2, and 2.3.6.6.3.1 through 2.3.6.6.3.5, the ceiling sprinkler system can be designed using the applicable protection table (i.e., Tables 7 through 11, depending on the commodity hazard being protected) based on a ceiling height that is obtained by taking the vertical distance between the top level of in-rack sprinklers and the actual ceiling above. In other words, the top level of in-rack sprinklers can be considered a floor for design purposes. See Figure 22 for a visual representation of this guidance. Note that the maximum storage height of 10 ft (3.0 m) above the top level of in-rack sprinklers outlined in Section 2.3.4 does not apply to this in-rack sprinkler arrangement. When the storage above the top level of in-rack sprinklers is limited to a maximum height of 5 ft (1.5 m), the ceiling sprinkler system design can be determined as previously indicated, but using protection Tables 2 through 6, as opposed to protection Tables 7 through 11, based on the commodity hazard being protected. If no storage is to be located above the top level of in-rack sprinklers, design the ceiling sprinkler system using the minimum ceiling height indicated within the applicable protection table (see Tables 2 through 6) for the commodity hazard being protected.

The water supply must be capable of providing the required design for the ceiling sprinkler system independent of the design requirements of the in-rack sprinkler system. It is not necessary to hydraulically balance the ceiling sprinkler system with the in-rack sprinkler system, nor account for them flowing simultaneously.

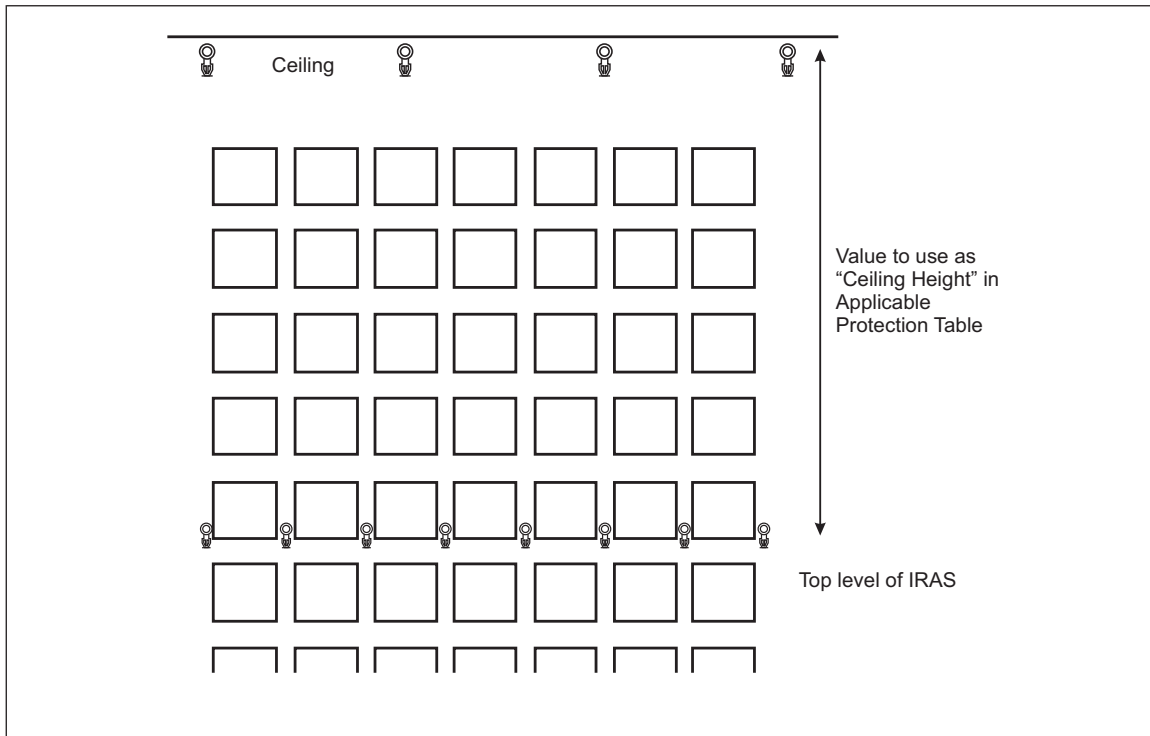

Fig. 22. Determining ceiling height in applicable protection table

2.3.6.7 Retrofit In-Rack Sprinkler Protection Solution for Uncartoned Unexpanded Plastics Stored in Single-Row Racks Wider than 3 ft (0.9 m) or in Double-Row Racks Protected by In-Rack Sprinklers Installed Only in the Longitudinal Flue Space

2.3.6.7.1 General

Uncartoned unexpanded plastic commodities maintained in the following storage arrangements cannot be adequately protected by a single line of in-rack sprinklers:

- A. Open-frame single-row racks wider than 3 ft (0.9 m), or
- B. Open-frame double-row racks without horizontal barriers, or
- C. Open-frame double-row racks wider than 9 ft (2.7 m) with horizontal barriers, or
- D. Open-frame double-row racks with horizontal barriers where the commodity extends more than 3 in. (75 mm) beyond the edge of the horizontal barrier

Where uncartoned unexpanded plastics are not adequately protected by the presence of a single line of in-rack sprinklers, follow the in-rack sprinkler retrofit recommendations provided in this section.

2.3.6.7.2 Occupancy

The retrofit designs in this section can be used to protect all commodities addressed in this data sheet.

Do not use the in-rack sprinkler retrofit designs in this section to protect open-top containers, unless they are located on the bottom tier level. Storage racks are considered "open-frame" as defined in Appendix A.

2.3.6.7.3 Protection

2.3.6.7.3.1 In-Rack Sprinkler System

The retrofit in-rack sprinkler designs in this section are for wet-pipe systems only.

2.3.6.7.3.2 In-Rack Sprinklers

Use FM Approved storage (ceiling) sprinklers that are standard-coverage, quick-response, pendent, minimum K22.4 (K320), and have a nominal temperature rating of 160°F (70°C).

2.3.6.7.3.3 Horizontal Location of In-Rack Sprinklers

For single-row racks more than 3 ft (0.9 m) and up to 6 ft (1.8 m) deep, remove the existing in-rack sprinklers at the tier levels where new in-rack sprinklers are recommended. See Figure 23 for a visual representation of this protection arrangement.

For double-row racks, follow the protection guidelines indicated for face sprinklers; the existing in-rack sprinklers in the longitudinal flue space do not have to be replaced. See Figure 24 for a visual representation of this protection arrangement when the storage rack is not more than 9 ft (2.7 m) deep.

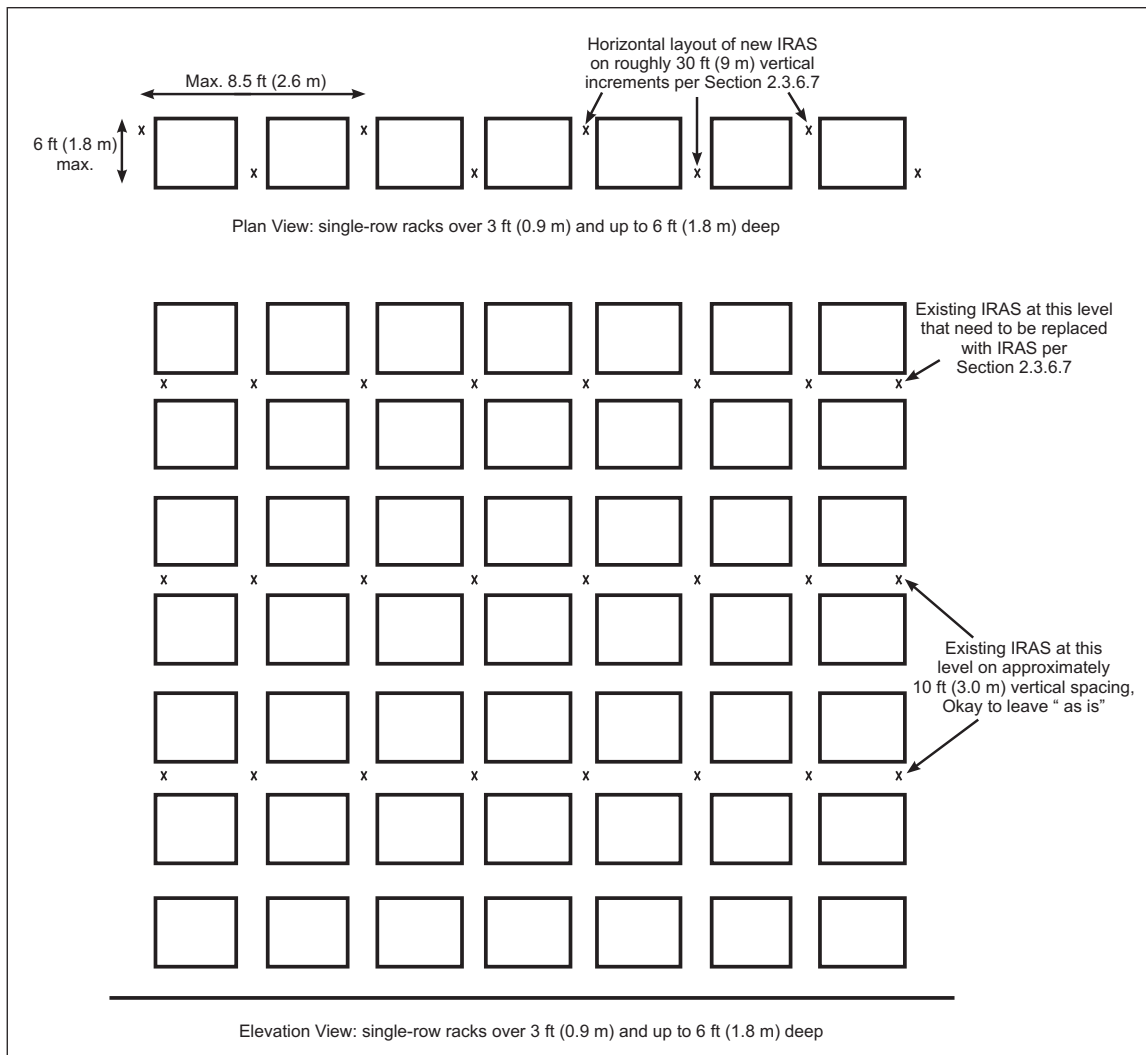

Fig. 23. Protection of uncartoned plastics in open-frame, single-row racks over 3 ft (0.9 m) and up to 6 ft (1.8 m) deep

The maximum recommended horizontal distance between face sprinklers and either (a) the face of the storage rack, or (b) the outer edge of the pallet load if it protrudes into the aisle, is 18 in. (450 mm). Locate all in-rack sprinklers within the footprint of the rack structure they are intended to protect. In-rack sprinklers protecting the flue space created between a single-row rack structure and a wall located within 12 in. (300 mm) horizontally of the rack structure can be positioned outside the footprint of the single-row rack structure as shown in Figure 19c.

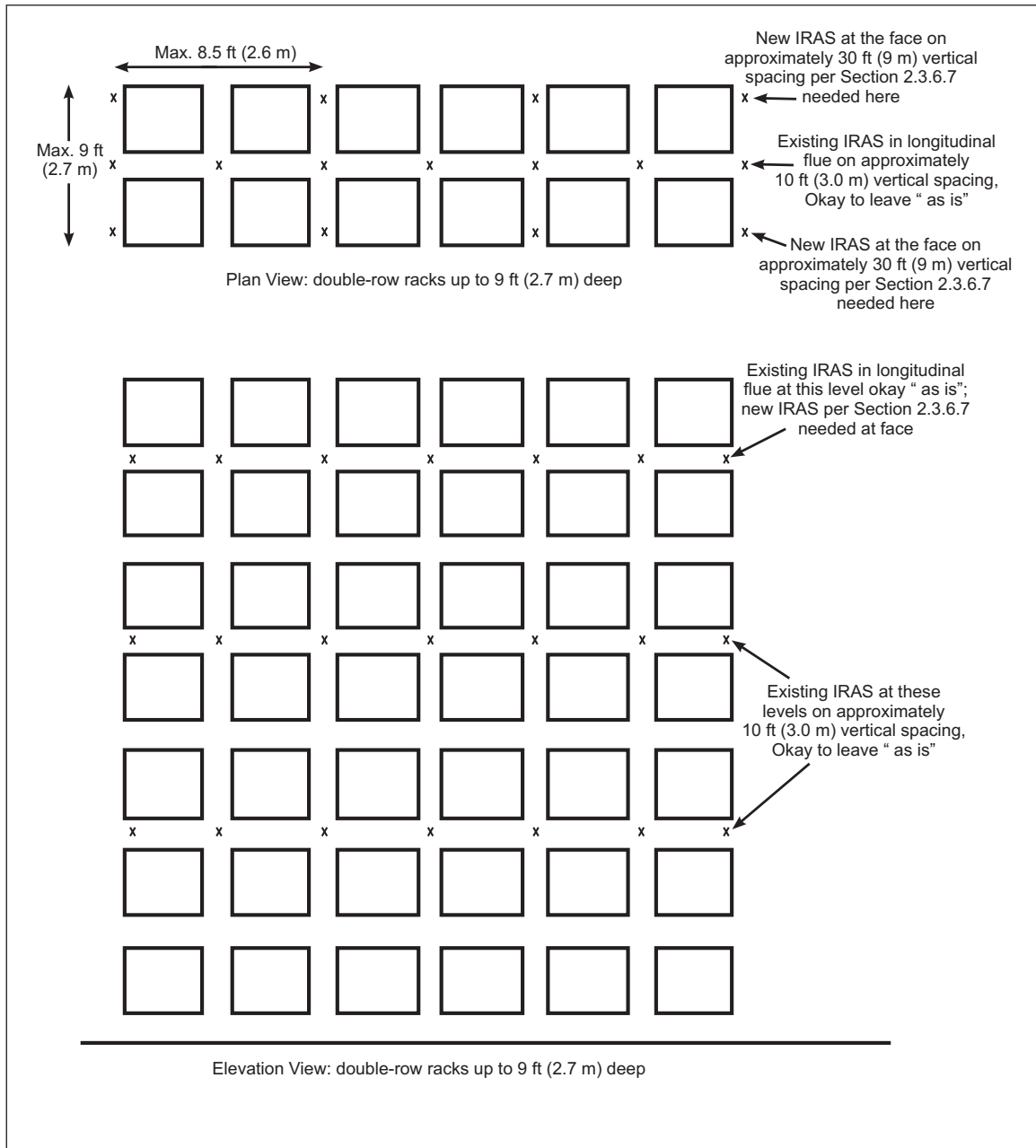

Fig. 24. Protection of uncartoned plastics in open-frame, double-row racks up to 9 ft (2.7 m) deep

Arrange sprinkler piping and in-rack sprinklers to avoid mechanical damage, but ensure proper distribution from the in-rack sprinkler can be achieved. Prior to installing in-rack sprinklers, check the proposed in-rack sprinkler locations to ensure both adequate protection against mechanical damage and proper sprinkler discharge are provided.

2.3.6.7.3.4 Vertical Location of In-Rack Sprinklers

The maximum recommended vertical distance between in-rack sprinkler levels is 30 ft (9.0 m).

In addition, the maximum recommended storage height above the top level of retrofit face in-rack sprinklers is 5 ft (1.5 m). The maximum storage height above the top level of retrofit face sprinklers can be increased

to 10 ft (3.0 m) when the ceiling sprinkler system can provide the design indicated per Table 13 (consider the IRAS arrangement as “IRAS(E)”) for a storage height above the top level of in-rack sprinklers of “over 5 ft (1.5 m) and up to 10 ft (3.0 m).”

Provide a minimum vertical clearance of 6 in. (150 mm) between the top of storage and the sprinkler deflector. At each tier level where in-rack sprinklers are needed, position the in-rack sprinkler deflector at or just below the bottom of the rack’s horizontal support member when it is under full-load conditions.

2.3.6.7.3.5 In-Rack Sprinkler System Design

Regardless of the number of in-rack sprinkler levels installed, base the in-rack sprinkler system design on the single most hydraulically remote in-rack sprinkler level. Base the minimum number of retrofit face in-rack sprinklers in the system design per Table 17.

Base the minimum flow required from the most remote face in-rack sprinkler on a flow of 120 gpm (455 L/min).

The retrofit in-rack sprinkler design does not need to account for any existing in-rack sprinklers flowing nor does it have to be hydraulically balanced with the existing overhead ceiling sprinkler system.

As part of the retrofit in-rack sprinkler system design, include a hose stream allowance of 250 gpm (950 L/min) for manual extinguishment. Allow at least 100 gpm (380 L/min) for inside hose stream usage, when provided, and add the balance of the hose demand to the overall retrofit in-rack sprinkler demand at the point of connection.

Arrange the water supply to provide the required retrofit in-rack sprinkler system demand and hose stream allowance (when taken from the same water supply feeding the in-rack sprinkler system) for a minimum of 60 minutes.

2.3.6.7.3.6 Ceiling Sprinkler System Design

Determine the ceiling-level sprinkler system’s recommended design per Table 13 using an in-rack sprinkler arrangement (IRAS arrangement) of “IRAS(E).” If the existing ceiling-level sprinklers are K5.6 (K80) or K8.0 (K115), or if the existing ceiling-level sprinkler system is not capable of providing the indicated ceiling design for (a) a storage height of up to 5 ft (1.5 m), or (b) a storage height of over 5 ft (1.5 m) and up to 10 ft (3.0 m), then install the recommended retrofit face sprinklers above the top of storage.

Table 17. Number of Face In-Rack Sprinklers in the Retrofit In-Rack Design

IRAS Installation Figure Used	Number of Face In-Rack Sprinklers in the Retrofit In-Rack Design	
	Class 1 through 4 Cartoned Plastics and Uncartoned Unexpanded Plastics	Uncartoned Expanded Plastics
Single-row racks over 3 ft (0.9 m) and up to 6 ft (1.8 m) deep (Fig. 19b)	3	4
Single-row rack over 3 ft (0.9 m) and up to 6 ft (1.8 m) deep against wall (Fig. 19c)	3	4
Double-row rack up to 9 ft (2.7 m) deep (Fig. 20a)	4	3 & 3 (6 total)*
Double-row rack over 9 ft (2.7 m) and up to 12 ft (3.6 m) deep (Fig. 20b)	5	4 & 4 (8 total)*

*The number of sprinklers indicated is based on the most remote in-rack sprinklers in both the most remote storage rack as well as the most remote adjacent sprinkler rack.

2.3.6.8 K25.2EC (K360EC) Pendent In-Rack Sprinkler Protection of Class 1, 2, 3, 4 and Cartoned Unexpanded Plastics in Open-Frame Racks in Combination with Horizontal Barriers

2.3.6.8.1 Commodity

2.3.6.8.1.1 This in-rack sprinkler protection option applies to Class 1 through 4 and cartoned unexpanded plastics only. It does not apply to cartoned expanded plastics nor any uncartoned plastics.

2.3.6.8.1.2 All storage containers must be closed top.

2.3.6.8.2 Storage Racks

2.3.6.8.2.1 Storage racks must meet the definition of open-frame rack storage (see the definition in Appendix A).

2.3.6.8.2.2 Arrange the storage racks so that any material overhang into the aisles is limited to a maximum of 3 in. (75 mm). If this overhang will exceed 3 in. (75 mm), see Sections 2.3.6.8.6.5 and 2.3.6.8.7.4 regarding the design requirements for both the in-rack and ceiling-level sprinkler systems.

2.3.6.8.2.3 Install horizontal barriers at every level where in-rack sprinklers are provided. The horizontal barrier must span the entire storage bay between uprights, including across the longitudinal flue space, if one exists. The horizontal barrier does not need to extend into the transverse flue space created by the rack uprights.

2.3.6.8.3 In-Rack Sprinkler System

The in-rack sprinkler system must be wet-pipe.

2.3.6.8.4 In-Rack Sprinklers

Install FM Approved quick-response, K25.2EC (K360EC) pendent Storage (Ceiling) sprinklers having a nominal temperature rating of either 160°F (70°C) or 212°F (100°C) under each horizontal barrier.

2.3.6.8.5 In-Rack Sprinkler Spacing and Location

2.3.6.8.5.1 Horizontal In-Rack Sprinkler Spacing and Location

2.3.6.8.5.1.1 The minimum and maximum allowable horizontal linear spacing for the in-rack sprinklers is 7 ft (2.1 m) and 8 ft 3 in. (2.5 m), respectively.

2.3.6.8.5.1.2 The minimum and maximum allowable horizontal area spacing for the in-rack sprinklers is 49 ft² (4.6 m²) and 68 ft² (6.3 m²), respectively.

2.3.6.8.5.1.3 The allowable horizontal linear spacing can be 4 ft 2 in. (1.3 m) or less when the area spacing of the in-rack sprinklers is 17.5 ft² (1.6 m²) or less.

2.3.6.8.5.1.4 Do not locate in-rack sprinklers closer than 1 ft (0.3 m) horizontally from rack uprights within single-row racks, or within double-row racks up to 9 ft (2.7 m) wide.

Exception: In-rack sprinklers can be located less than 1 ft (0.3 m) horizontally from rack uprights in either single-row racks or double-row racks up to 9 ft (2.7 m) wide when the maximum horizontal linear spacing of the in-rack sprinklers is 4 ft 2 in. (1.3 m) and the maximum area spacing is 17.5 ft² (1.6 m²).

2.3.6.8.5.1.5 Locate all in-rack sprinklers under the footprint of the horizontal barrier.

2.3.6.8.5.1.6 For single-row racks, the in-rack sprinklers may be located outside the footprint of the storage rack when all the following conditions are satisfied:

- (1) The in-rack sprinklers are located within 6 in. (150 mm) horizontally of the rack structure, and
- (2) The horizontal barrier extends outside the footprint of the rack a minimum 1 in. (25 mm) beyond the in-rack sprinklers, and
- (3) The horizontal location of the in-rack sprinklers is in accordance with Sections 2.3.6.8.5.1.1 through 2.3.6.8.5.1.3, and
- (4) The vertical location of the in-rack sprinklers is in accordance with Sections 2.3.6.8.5.2.2 and 2.3.6.8.5.2.3

2.3.6.8.5.1.7 For double-row racks, arrange the in-rack sprinklers horizontally as follows:

- (1) For a maximum rack depth of 9 ft (2.7 m), install one line of sprinklers down the center of the rack.
- (2) For a rack depth over 9 ft (2.7 m) and up to 12 ft (3.6 m), install two lines of face sprinklers, each within 18 in. (450 mm) of the rack face. Stagger the sprinklers horizontally, as needed, to meet the minimum in-rack sprinkler spacing requirements outlined in Section 2.3.6.8.5.1.1. The in-rack sprinklers do not need to be staggered if the linear spacing is in accordance with Section 2.3.6.8.5.1.3.

2.3.6.8.5.1.8 For multiple-row racks, in addition to the spacing requirements outlined in Sections 2.3.6.8.5.1.1 through 2.3.6.8.5.1.3, locate in-rack sprinklers within 18 in. (450 mm) horizontally from the face of the storage rack.

2.3.6.8.5.2 Vertical In-Rack Sprinkler Spacing and Location

2.3.6.8.5.2.1 The maximum vertical distance between in-rack sprinklers is 30 ft (9.0 m).

2.3.6.8.5.2.2 Position the in-rack sprinkler deflectors below the underside of each horizontal barrier at a vertical distance not exceeding 7 in. (175 mm).

2.3.6.8.5.2.3 The minimum vertical clearance between the top of storage and the in-rack sprinkler deflector is 9 in. (225 mm).

2.3.6.8.6 In-Rack Sprinkler System Design

2.3.6.8.6.1 In-Rack Sprinkler System Design: Minimum Required Flow

Use a minimum flow of 160 gpm (605 L/min) from the hydraulically most remote in-rack sprinkler.

2.3.6.8.6.2 In-Rack Sprinkler System Design: Minimum Number of Operating In-Rack Sprinklers

See Table 17a to determine the minimum number of in-rack sprinklers to be included in the in-rack sprinkler design. These in-rack sprinklers are all on the single most hydraulically remote tier level that is provided with in-rack sprinkler protection.

Table 17a. Minimum Number of K25.2EC (K360EC) Pendent In-Rack Sprinklers Included in the In-Rack Sprinkler Design

Rack Type	Rack Depth, ft (m)	Aisle Width, ft (m)	No. of IRAS in Design
Single-Row Rack	Up to 6 ft (1.8 m)	Up to 4 ft (1.2 m)	6 total; 3 in most remote rack and 3 in nearest adjacent rack
		Over 4 ft (1.2 m)	3 in most remote rack
Double-Row Rack	Up to 9 ft (2.7 m)	Up to 4 ft (1.2 m)	8 total; 4 in most remote rack and 4 in nearest adjacent rack
		Over 4 ft (1.2 m)	4 in most remote rack
	Over 9 ft (2.7 m)	Any	8 total; 4 on each rack face in most remote rack
Multiple-Row Rack	Any	Any	8 total; 4 along the rack face and the nearest 4 adjacent sprinklers in most remote rack

2.3.6.8.6.3 In-Rack Sprinkler System Hose Stream Allowance and System Duration

2.3.6.8.6.3.1 As part of the in-rack sprinkler system demand include a hose stream allowance of 250 gpm (950 L/min) for manual extinguishment. Allow at least 100 gpm (380 L/min) for inside hose stream usage, when inside hose station connections are provided, and add the balance of the hose demand to the overall in-rack sprinkler system demand at the point of connection to the water supply.

2.3.6.8.6.3.2 Arrange the water supply to provide the required in-rack sprinkler system demand and hose stream allowance (when taken from the same water supply feeding the in-rack sprinkler system) for a minimum of 60 minutes.

2.3.6.8.6.4 When material overhang beyond the horizontal barrier is limited to a maximum of 3 in. (75 mm) as outlined in Section 2.3.6.8.2.2, the in-rack sprinkler system does not have to be hydraulically balanced with the ceiling-level sprinkler system, nor does it have to be added together with the ceiling-level sprinkler system design.

2.3.6.8.6.5 When material overhang beyond the horizontal barrier exceeds 3 in. (75 mm), hydraulically balance the in-rack sprinkler system and the ceiling-level sprinkler system at their point of connection.

2.3.6.8.7 Ceiling-Level Sprinkler System Design

2.3.6.8.7.1 Design and install the ceiling-level sprinkler system in accordance with the guidelines in Section 2.3, except as modified in this section.

2.3.6.8.7.2 When the in-rack sprinkler system is designed and installed in accordance with Sections 2.3.6.8.1 through 2.3.6.8.6, the ceiling-level sprinkler system can be designed using the applicable protection table

(i.e., Tables 7 through 11, depending on the commodity hazard being protected) based on a ceiling height that is obtained by taking the vertical distance between the top level of in-rack sprinklers and the actual ceiling above. In other words, the top level of in-rack sprinklers can be considered a floor for design purposes. See Figure 22 of Section 2.3.6.6 for a visual representation of this guidance. Note that the maximum storage height of 10 ft (3.0 m) above the top level of in-rack sprinklers outlined in Section 2.3.4 does not apply to this in-rack sprinkler arrangement. If no storage is to be located above the top level of in-rack sprinklers, base the ceiling sprinkler system design on the minimum ceiling height indicated within the applicable protection table for the commodity hazard being protected.

2.3.6.8.7.3 When material overhang beyond the horizontal barrier is limited to a maximum of 3 in. (75 mm) as outlined in Section 2.3.6.8.2.2, the ceiling-level sprinkler system does not have to be hydraulically balanced with the in-rack sprinkler system, nor does it have to be added together with the in-rack sprinkler system design.

2.3.6.8.7.4 When material overhang beyond the horizontal barrier exceeds 3 in. (75 mm), hydraulically balance the ceiling-level sprinkler system and the in-rack sprinkler system at their point of connection.

2.3.6.9 Ceiling-Only Sprinkler Protection Recommendations for Ceiling Heights Over 40 ft (12.0 m)

2.3.6.9.1 A ceiling-only sprinkler system using quick-response, standard-coverage, 160°F (70°C) nominally rated pendent Storage sprinklers can be installed when all the conditions outlined in Table 17b have been met.

2.3.6.9.2 The ceiling sprinkler system must be wet pipe; pre-action sprinkler systems designed to meet a wet sprinkler system design do not qualify for these designs.

2.3.6.9.3 Storage racks must meet the definition of open-frame and are limited to single-row and double-row only; multiple-row racks do not qualify for these designs.

2.3.6.9.4 Commodities applicable for these designs include Class 1, 2, 3, 4 and cartoned unexpanded plastics. These designs do not apply to cartoned expanded plastics nor any uncartoned plastics (unexpanded or expanded).

2.3.6.9.5 For buildings with mineral wool or glass fiber insulation between the vertical structural supports (such as purlins), the vertical distance between the underside of the ceiling and the centerline of the sprinkler's thermal element can be measured as shown in Figure 25.

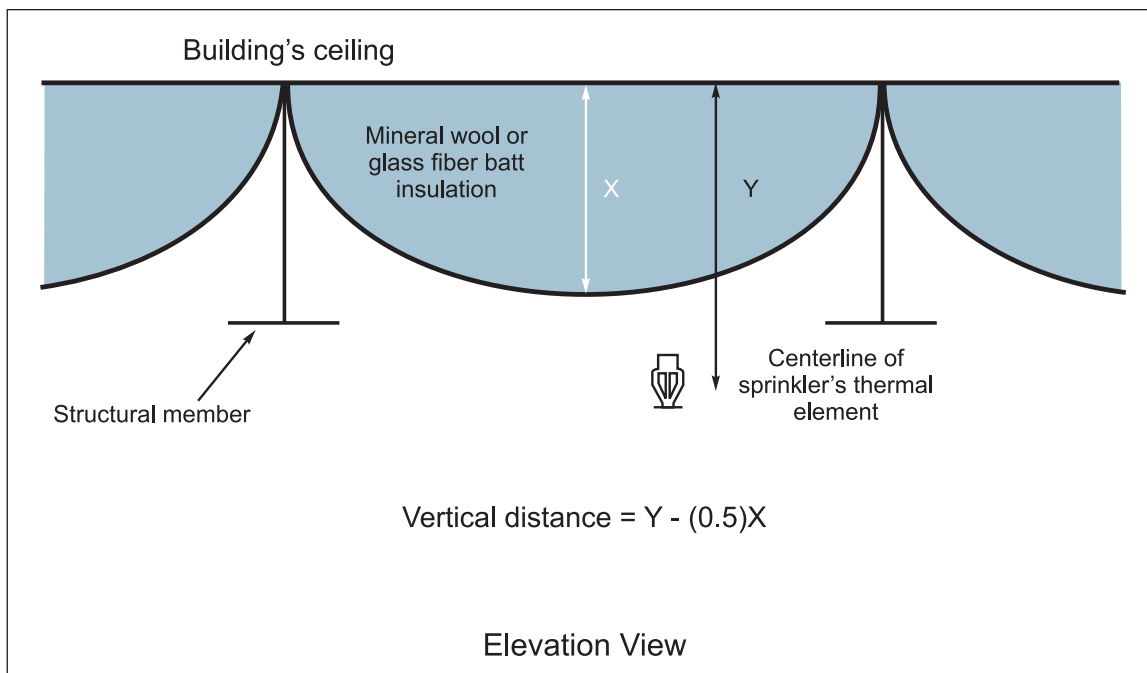

Fig. 25. Vertical distance between ceiling and centerline of sprinkler's thermal element in the presence of mineral wool or glass fiber batt insulation.

2.3.6.9.6 For ceiling sprinkler designs indicated as 9 sprinklers, base the hydraulic design on the most remote 3 sprinklers operating on the most remote 3 branchlines. For ceiling sprinkler designs indicated as 10 sprinklers, base the hydraulic design based on the following:

- a. For ceiling slopes up to 5 degrees, base the hydraulic design on the most remote 3 sprinklers operating on the most remote 3 branchlines plus 1 sprinkler operating on the most remote fourth branchline.
- b. For ceiling slopes over 5 degrees, base the hydraulic design on the most remote 4 sprinklers operating on the most remote 2 branchlines plus an additional 2 sprinklers operating on the most remote third branchline.

Table 17b. Quick-Response, 160°F (70°C) Nominally Rated, Standard-Coverage Pendent Storage Sprinkler Ceiling-Only Designs for Ceiling Heights Over 40 ft (12.0 m)

Storage Arrangement	Commodity	Max. Storage Height, ft (m)	Max. Ceiling Height, ft (m)	Ceiling Sprinkler K-Factor	Max. Vertical Distance from Ceiling to Sprinkler's Thermal Element, in. (mm)	Min. Aisle Width, ft (m)	Sprinkler System Design		
							Ceiling Sprinkler System, No. of AS @ psi (bar)	Hose Demand, gpm (L/min)	System Duration, min
Solid-Piled, Palletized, Bin-Box, Shelf, and Open-Frame Racks*	Class 1, 2, 3, 4 and Cartoned Unexpanded Plastics	45 (13.7)	50 (15.2)	22.4 (320)	13 (325)	6 (1.8)	10 @ 63 (4.3)	250 (950)	60
				25.2 (360)	13 (325)	6 (1.8)	10 @ 50 (3.5)		
					17 (425)	6 (1.8)	10 @ 75 (5.2)		
				28.0** (400**)	13 (325)	6 (1.8)	10 @ 40 (2.8)		
			33.6 (480)	6 (1.8)	9 @ 55 (3.8)				
		50 (15.2)	55 (16.8)	28.0 (400)	13 (325)	8 (2.4)	9 @ 80 (5.5)		
				33.6 (480)	17 (425)	6 (1.8)	9 @ 55 (3.8)		

* See the definition of Open-Frame Rack Storage in Appendix A to confirm that any multiple-row racks being protected in accordance with this table meet the requirements to be considered open-frame

** The design of 10 AS @ 40 psi (2.8 bar) can be reduced to 9 AS @ 40 psi (2.8 bar) when the water supply can also provide a minimum pressure of 80 psi (5.5 bar) from the most remote 4 sprinklers (2 sprinklers on 2 lines).

2.3.6.9.7 Commodities Up to and Including Uncartoned Unexpanded Plastics: Ceiling Heights up to 45 ft (13.5 m)

Protect maximum 25 ft (7.5 m) high on-floor storage of commodity hazards up to and including uncartoned unexpanded plastics maintained under a maximum ceiling height of 45 ft (13.5 m) as follows:

- A. The sprinkler system must be a wet system (pre-action sprinkler systems do not qualify).
- B. Sprinklers are quick response, 160°F (70°C) nominally rated, minimum K25.2 (K360) pendent Storage sprinklers and installed in accordance with FM Global Property Loss Prevention Data Sheet 2-0, *Installation Guidelines for Automatic Sprinklers*.
- C. The sprinkler design is a minimum of 12 sprinklers operating at a minimum pressure of 60 psi (4.1 bar) allowing for a hose demand of 250 gpm (950 L/min) and a sprinkler system duration of 60 minutes.

3.0 SUPPORT FOR RECOMMENDATIONS

3.1 General

The fire protection recommendations in this data sheet are based on testing, loss experience, and engineering judgment. Not every situation has been tested, nor has every potential solution been identified. Carefully consider all the variables involved when exploring options that differ from those recommended in this data sheet.

3.2 Loss History

Loss experience has shown that when there are no major automatic sprinkler system deficiencies, fires in storage occupancies are controlled by the existing sprinkler system protection arrangement. Major protection deficiencies include inadequate water supplies, closed or partially closed valves, obstructed sprinkler piping, missing sprinklers, and flammable liquid or aerosol protection deficiencies. Protection deficiencies were identified in all storage losses where the fire was uncontrolled.

Note that storage loss experience to date has involved primarily standard-response K5.6 (K80) or K8.0 (K115) sprinklers. Experience with K11.2 (K160) and larger sprinklers is limited due to their relatively recent development.

Some general deductions can be made from a study of rack storage losses (solid-piled/palletized losses have not been studied in similar detail) that occurred in a recent 18-year period, and in which no protection deficiencies were identified. These losses involve standard-response K5.6 (K80) and K8.0 (K115) sprinklers exclusively. The basic findings are as follows:

1. In-rack sprinklers, used in conjunction with ceiling-level sprinklers, are overwhelmingly successful.
2. Both the amount of damage and the number of sprinklers that open during a fire increase with higher storage / building heights.

The percentage of rack storage fires controlled by a given number of sprinklers is shown in the Table 18:

Table 18. Relationship Between the Number of Sprinklers that Operate During a Storage Fire and Fire Control

<i>Number of Sprinklers that Operate During a Fire</i>	<i>Percentage of Fires Controlled</i>
1	14%
2 or fewer	32%
3 or fewer	41%
4 or fewer	49%
5 or fewer	54%
10 or fewer	77%
25 or fewer	98%

For sprinkler systems consisting of ceiling-level sprinklers only, the average number of sprinklers that opened during a storage fire was eight. For sprinkler systems consisting of the combination of ceiling-level and in-rack sprinklers, the average number of sprinklers that opened during a storage fire was three ceiling-level sprinklers and three in-rack sprinklers.

The use of hoses use was identified in 87% of the incidents that operated ten or fewer sprinklers and, when hoses were used, they were applied either before sprinklers operated or before fire control was achieved in a little more than 50% of the cases. This strong correlation suggests early application of hose streams has a significant effect on the average number of sprinklers that operate in rack storage fires (it would follow that this is also true for solid-piled / palletized storage fires), and that provision of small hose stations is a key element in the overall protection scheme. It is impossible to say how many catastrophic fires may have been prevented by early intervention using hoses.

3.3 Illustrative Losses

3.3.1 Roll Cloth in Racks Obstruct Flue Spaces, Resulting in Extensive Fire and Water Damage

At a large textile facility, 8 to 9 ft (2.4 to 2.7 m) long, encapsulated, finished roll cloth was stored in open-frame double-row racks up to 12 ft (3.7 m) high on the third floor of a warehouse.

The rolls were only one high per tier, and were packed tightly due to high production demands. This abutment of the rolls obstructed water from penetrating into the racks and only left about a 1 in. (25 mm) flue at most of the 10 ft (3.0 m) uprights. A fire started on the bottom tier and traveled down the length of the rack for 30 ft (9.0 m) in each direction before the sprinkler system achieved enough penetration to gain control of the fire. During the fire, 91 sprinklers operated, but the facility had a strong water supply with an unlimited water source. Approximately 200 rolls of cloth were damaged by fire, and all other rolls of cloth and finished goods in the area were damaged by smoke and water to various degrees. There was extensive water damage to finished goods stored in a basement area in an adjoining building with wooden intermediate floors.

3.3.2 Many Loss Prevention Principles Compromised in Warehouse Fire

Temporary aisle storage of palletized plastic automobile consoles, portable racked steel core steering wheels with polyurethane foam padding and PVC skin, and palletized motor oil were introduced into an automotive parts and accessories warehouse. In most areas of the warehouse, portable racks were stacked six high to a total height of about 20 ft (6.0 m). Permanent racks were 10 ft (3.0 m) high and usually had another 10 ft (3.0 m) of baskets stacked on top. The ceiling-level sprinkler system was only capable of protecting these commodities in the indicated storage arrangements to a maximum height of 5 ft (1.5 m) based on the available water supply.

A fire, probably caused by smoking, resulted in the largest loss FM Global had investigated up to that time. The storage was too high, the sprinkler water application was too low, sprinkler orifice sizes and temperature ratings were incorrect, temporary storage blocked the aisles, and there were no flue spaces.

3.3.3 Inadequate Sprinkler Protection Unable to Control Fire Involving Aisle Storage and Racks with Solid Shelves

Clothing and shoes were stored in single-row racks from 22 to 26 ft (6.6 to 7.9 m) high. Idle pallets up to 12 ft (3.7 m) high were stored in 6 ft (1.8 m) wide aisles between racks. Solid shelves were present in the lower two tiers to form picking bins. In-rack sprinklers were not provided. A fire starting in this area overtaxed the ceiling-level sprinkler system. Roof collapse occurred within 20 minutes of fire discovery. Approximately 200,000 ft² (18,500 m²) of this building was destroyed.

3.3.4 Fire in High Rack-Storage Controlled by In-Rack Sprinklers

Fire in clothing stored in cartons on 16-tier, 39 ft (11.9 m) high racks was well controlled by four in-rack sprinklers and one ceiling-level sprinkler. In-rack sprinklers were provided at four levels. Complete extinguishment was provided via two small hoses.

3.3.5 Lack of In-Rack Sprinklers for Racks With Solid Shelves Results in Extensive Fire Damage

Upholstered furniture was stored on cantilever racks to 15 ft (4.5 m) high. Racks were 8 ft (2.4 m) deep and equipped with 56 ft² (5.2 m²) solid plywood shelves. In-rack sprinklers were not provided. A fire starting in the rack storage quickly overtaxed ceiling-level sprinklers, with initial roof collapse occurring within 20 minutes of fire discovery. Approximately half of the 202 by 405 ft (60 by 120 m) building's roof collapsed and storage burned. Roof collapse remote from the point of fire origin apparently hindered further horizontal fire spread by blocking flames from reaching uninvolved areas.

3.3.6 Open-Top Containers in Racks Interfere with Sprinkler Water Penetration Resulting in Uncontrolled Fire

Synthetic fiber socks were stored in open-top cardboard "tote boxes" in racks 16 ft (4.8 m) high. There were eight levels of boxes supported on metal angles in each rack. A fire started in or near the racks and water from ceiling-level sprinklers collected in boxes on the top tier levels, preventing adequate sprinkler water from penetrating through the racks to control the fire. A 390 by 530 ft (120 by 160 m) portion of the facility was destroyed. In-rack sprinklers were provided when the facility was rebuilt.

3.3.7 Poor Housekeeping Leads to Excessive Fire Spread

Solid-pile storage of 10 ft (3.0 m) high rolled and baled synthetic greige goods in burlap wrapping (a Class IV commodity) was located in a one-story, 6800 ft² (630 m²) section of a warehouse. There was 4 ft (1.2 m) clearance to ceiling sprinklers. Protection was by a dry-pipe sprinkler system with 100 ft² (9.0 m²) spacing using K5.6 (K80), 160°F (70°F) nominally rated ceiling-level sprinklers. The system was supplied by public water and a manually started fire pump rated at 1000 gpm (3800 L/min) at 100 psi (6.9 bar), capable of delivering a minimum pressure of 8 psi (0.6 bar) to the most remote 30 sprinklers, without supplying mill use or hose streams.

The plant engineer noted a rapidly spreading fire in lint accumulations in the corner of the warehouse near a baling machine. The emergency response team (ERT) and public fire service responded within ten minutes. The fire was controlled by 68 operating sprinklers and extinguished within one hour when ceiling-level sprinklers were supplemented by one large and three small hose streams. Approximately 150 bales and 200 rolls of greige goods were wet by the sprinkler system. Wood building walls and roof were scorched and charred.

Weak water supplies (water supplies to sprinklers were depleted by mill use and hose streams) and lint accumulations combined to permit excessive fire development. The manual fire pump was not started for fear of contaminating mill-use water supplies.

3.3.8 Strong Water Supply Overcomes Plugged Sprinklers

Palletized storage of 12 ft (3.7 m) high, cartoned paperboard flats (a Class 3 commodity) with 4 ft (1.2 m) clearance to ceiling-level sprinklers was in a one-story warehouse. Protection was provided by a dry-pipe sprinkler system with 64 ft² (6.0 m²) spacing with K5.6 (K80), 280°F (140°C) nominally rated ceiling-level sprinklers. The system was supplied by an automatic fire pump rated at 1500 gpm (5700 L/min) at 100 psi (6.9 bar) and capable of providing a minimum pressure of 93 psi (6.4 bar) over the most remote 38 sprinklers on 64 ft² (6.0 m²) spacing.

The public fire service was notified of the storage fire 30 minutes after the alarm and achieved extinguishment within one hour, using three small hoses. A total of 20 ceiling-level sprinklers opened and controlled limiting the damage to 30 pallet loads of cartoned paperboard flats and 250 ft² (23 m²) of charred ceiling.

An investigation of the 20 sprinklers that opened during the fire indicated that 10 of them were plugged with stones. The remaining 10 operating sprinklers were able to limit the fire spread in large part because the existing water supplies were able to provide well in excess of the normal recommended water application for the array and product.

4.0 REFERENCES

4.1 FM Global

Data Sheet 1-2, *Earthquakes*
Data Sheet 1-10, *Smoke and Heat Venting in One-story Sprinklered Buildings*
Data Sheet 1-12, *Ceilings and Concealed Spaces*
Data Sheet 1-24, *Protection Against Liquid Damage*
Data Sheet 2-0, *Installation Guidelines for Automatic Sprinklers*
Data Sheet 2-8, *Earthquake Protection for Water-Based Fire Protection Systems*
Data Sheet 5-48 *Automatic Fire Detection*
Data Sheet 7-29, *Ignitable Liquid Storage in Portable Containers*
Data Sheet 8-1, *Commodity Classification*
Data Sheet 8-24, *Idle Pallet Storage*
Data Sheet 8-29, *Refrigerated Storage*

APPENDIX A GLOSSARY OF TERMS

Aisle: An aisle is a clear space of greater than 2 ft (0.6 m) normally maintained between commodities stored either in racks or on the floor. The aisle allows for the transfer of commodities to or from the rack or the on-floor storage area.

Approval Guide: An online resource of FM Approvals that provides a guide to equipment, materials, and services that have been FM Approved for property conservation.

Bin-Box Storage: A storage arrangement that typically consists of solid shelves vertically located no more than 3 ft (0.9 m) apart in combination with solid full-height wooden or metal vertical barriers that are horizontally located no more than 4 ft (1.2 m) apart. There is usually a solid backing for each bin-box storage unit, but this is not always the case. While this type of storage arrangement typically shields direct water application to the burning commodity maintained within each bin-box storage unit, the relatively low tier height between solid shelves coupled with the full-height vertical barriers help to reduce the heat release rate of the fire as well as severely delay its potential for horizontal fire growth.

Clearance: The clear space maintained between the top of storage and the deflector of the sprinkler (ceiling or in-rack) located above it. For all ceiling-level sprinklers, a minimum clearance of 3 ft (0.9 m) is required. For all in-rack sprinklers installed in an IRAS(EO) arrangement, the deflector must be located a minimum of 6 in. (150 mm) above the top of storage.

Commodity: A commodity is the combination of product, packaging material, container, and material handling aids (e.g., pallets). Data Sheet 8-1, *Commodity Classification*, contains commodity classification guidelines that are applicable to this data sheet. The purpose of assigning a commodity classification is to allow specification of the proper level of fire protection. A commodity classification is dependent on how the product burns and how the burning product responds to the application of sprinkler discharge. Protection specifications in this data sheet are based on the following categories of commodity:

- Class 1, Class 2, and Class 3 commodity hazards
- Class 4 commodity hazards and Cartoned Unexpanded Plastics
- Uncartoned Unexpanded Plastics
- Cartoned Expanded Plastics
- Uncartoned Expanded Plastics

Duration or System Duration: Water supply system duration is a defined time period between when a fire initially activates a sprinkler system and when the fire is extinguished. Fire extinguishment usually is accomplished by the manual firefighting efforts of public fire service personnel, facility fire service personnel, or facility emergency response team personnel applying hose streams directly onto the surfaces of the burning commodity. Duration takes into consideration the commodity hazard's expected fire size in the presence of the system's specific sprinklers, as well as manual fire extinguishment by either one or two applied hose streams.

Encapsulation: A method of packaging consisting of a plastic sheet completely enclosing the sides and top of a pallet load containing a combustible commodity or a group of combustible commodities or combustible packages. Totally noncombustible commodities on wood pallets enclosed only by a plastic sheet as described above are not considered to be encapsulated. The term "encapsulation" also applies to individual cartons that are enclosed on the top and sides in plastic, and to cartons waterproofed by coatings on the exterior surfaces.

The term "encapsulation" does not apply to individual plastic enclosed items inside a larger non-plastic enclosed or non-waterproofed container. If holes or voids in the plastic or waterproof cover on the top of the carton exceed more than half the area of the top, the term "encapsulation" does not apply.

The protection design guidelines provided in this data sheet account for the presence of encapsulation and do not need to be adjusted.

Fire Protection Scheme 8-9A: A specific fire protection scheme that uses both horizontal barriers and quick-response in-rack sprinklers to protect high-challenge commodities that would otherwise (1) require a significantly higher ceiling-level design and/or water supply to protect it, or (2) require in-rack sprinklers whereas a ceiling-only option is available for the other commodity hazards maintained within the storage area, or (3) require a higher number of in-rack sprinkler tier levels when compared to the number of tier levels required for the other commodity hazards maintained within the storage area.

By segregating the high-challenge commodities into a designated storage rack (or racks) that is equipped with Fire Protection Scheme 8-9A (i.e., Scheme 8-9A) protection, the sprinkler design for the storage area can then be based on the requirements for the highest commodity hazard not being protected by Scheme 8-9A protection. This protection scheme in essence treats the high-challenge commodities as if they have been removed from the storage area.

With Scheme 8-9A protection, the in-rack sprinkler system design is independent of the ceiling-level sprinkler system and does not have to be hydraulically balanced with it.

For example, the majority of a proposed 40 ft (12.0 m) high warehouse will contain commodity hazards ranging up to and including cartoned unexpanded plastics; however, it will also contain a small but significant amount of uncartoned expanded plastics. The existing water supply has the flow and pressure needed to support several ceiling-only protection options for cartoned unexpanded plastics; however, it is not sufficient to support any ceiling-only protection options for uncartoned expanded plastics. By segregating all of the uncartoned expanded plastics into a storage rack that is equipped with Scheme 8-9A protection, the ceiling-level sprinkler system can be designed based on the next highest commodity hazard; in this case cartoned unexpanded plastics.

This protection option can also be used at existing locations when new high-challenge commodity hazards are going to be introduced into a warehouse area where the existing ceiling-level sprinkler system does not have a sufficient design for the new high-challenge commodities.

Note that there are other options that involve the segregation of the high-challenge commodities into dedicated storage racks and protected by in-rack sprinklers that can be considered. Most of these options will be less stringent than the requirements outlined for Scheme 8-9A; the difference however is that with Scheme 8-9A protection the in-rack sprinkler system does not have to be hydraulically balanced with the ceiling-level sprinkler system. All options should be considered to determine which option works best for the specific conditions found at the storage location.

FM Approved: References to “FM Approved” in this data sheet mean the product or service has satisfied the criteria for FM Approval. Refer to the *Approval Guide* for a complete listing of products and services that are FM Approved.

Flue Spaces: The spaces between rows of storage. In rack storage, the longitudinal flue spaces are perpendicular to the direction of loading, and transverse flue spaces are parallel to the direction of loading (Fig. A-1). Flue spaces that are less than a net 3 in. (75 mm) wide are not considered flue spaces for fire protection purposes. In addition, any space between rows of storage that exceeds 24 in. (600 mm) horizontally is considered an aisle for fire protection design purposes.

Flue Space Net Width: The gross width of a flue space minus any horizontal or angled objects located within the flue space.

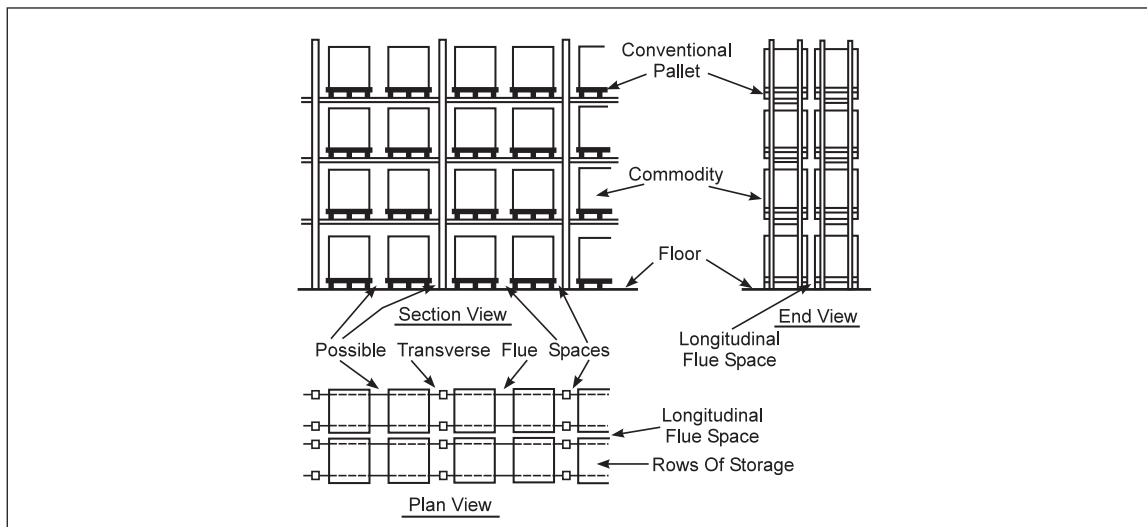

Fig. A-1. Typical double-row (back-to-back) rack arrangement

Horizontal Barriers: A solid barrier installed on a horizontal plane within a rack, beneath which in-rack sprinklers are installed. They are typically constructed of minimum 22 ga (0.7 mm) sheet metal; however, minimum 3/8 in. (10 mm) plywood can also be used. They extend to both ends and both aisle faces of the racks covering up both the longitudinal and transverse flue spaces of the rack bays in which they are installed. They are fitted to within 3 in. (75 mm) of any vertical rack member or other equipment that would

create an opening, such as vertical in-rack sprinkler pipe drops. Their purpose is to impede vertical fire spread by blocking off normally open flue spaces, while also helping to achieve prompt in-rack sprinkler operation by banking heat down to the in-rack sprinklers that must be installed under each barrier.

In-Rack Sprinklers: These sprinklers are typically K5.6 (K80), K8.0 (K115) or K11.2 (K160) Nonstorage sprinklers equipped with an attached water shield over the top of the thermal sensing element. The water shield prevents wetting of the thermal sensing element by water from sprinklers at a higher elevation in the rack or at ceiling level. Note that the water shield is not a heat collector and has virtually no effect on how fast the in-rack sprinkler will operate.

In-rack sprinklers are classified as either longitudinal in-rack sprinklers or face in-rack sprinklers. Both types of sprinklers are meant to be located within the transverse flue spaces of the storage array and positioned so that water can be delivered into the flue spaces they are intended to protect. If in-rack sprinklers are not located at every transverse flue space intersection, then the in-rack sprinklers must also be positioned such that they can discharge water across the top of any storage at the level the in-rack sprinklers are provided. Longitudinal in-rack sprinklers are located within the longitudinal flue spaces of a double-row or multiple-row rack, or down the middle of a single-row rack. Face in-rack sprinklers are located within the rack storage array at transverse flue spaces no more than 18 in. (450 mm) horizontally from the face of the rack. Both longitudinal and face in-rack sprinklers need to be positioned within 3 in. (75 mm) horizontally of their designated transverse flue space intersection. When in-rack sprinklers are required per the protection guidelines, refer to the appropriate in-rack sprinkler figure to determine the proper horizontal location of the in-rack sprinklers.

Longitudinal in-rack sprinklers help prevent horizontal fire spread down the length of the rack. Face in-rack sprinklers help prevent horizontal fire spread down the length of the rack as well as provide a water curtain between two adjacent racks to hinder fire jump across the aisle.

K-factor: Also known as the discharge coefficient, it is a numerical value representing the orifice size of the sprinkler in combination with the expected flow through the sprinkler orifice at a given pressure value. It is calculated using the following equation:

$$K = \frac{Q}{\sqrt{P}}$$

Where: Q is the flow through the sprinkler orifice in gpm (L/min).
 P is the pressure at the sprinkler orifice in psi (bar).
 The units for K are gpm/psi^{0.5} ([L/min]/bar^{0.5}).

See Table 1 for K-factor values of Storage sprinklers that are currently FM Approved.

Inspector’s Test Connection: A device consisting of a manual control valve, a section of sprinkler piping (allowing discharge to a safe location), and at least one smooth-bore corrosion-resistant orifice (no larger than the smallest orifice of any sprinkler installed on the sprinkler system that the inspector’s test connection serves). It is used to test the waterflow alarm mechanism provided for the sprinkler system as well as determine the water delivery time for a dry or similar type of sprinkler system. It is typically installed at the hydraulically remote end of a sprinkler system.

Movable Racks: Movable racks are on fixed rails or guides. They can be moved in one direction only in a horizontal two-dimensional plane. A moving aisle is created as abutting racks are loaded or unloaded, then moved across the aisle to abut other racks. Movable rack arrangements generally result in the same protection needs as those for multiple-row racks.

Nominal Temperature Rating: An indicated temperature rating that represents a given range applicable for the conditions the sprinkler is to be used for. This data sheet recommends sprinklers having nominal temperature ratings of 160°F (70°C), 212°F (100°C) or 280°F (140°C). The following indicates the ranges these nominal temperature ratings represent:

Nominal Temperature Rating, °F (°C)	Actual Temperature Range, °F (°C)
160 (70)	155 (68) - 165 (74)
212 (100)	200 (93) - 220 (104)
280 (140)	280 (138) - 286 (141)

8-9 Storage of Class 1, 2, 3, 4 and Plastic Commodities

Occupancy-Specific Data Sheet: An FM Global property loss prevention data sheet that addresses a specific occupancy hazard. Individual data sheets belong to a numbered "series" representing the following subjects:

<i>Series Number</i>	<i>Data Sheet Subject</i>
1	Construction
2	Sprinklers
3	Water supply
4	Extinguishing equipment
5	Electrical
6	Boilers and industrial heating equipment
7	Hazards
8	Storage
9	Miscellaneous
10	Human factor
11	Systems instrumentation and control
12	Pressure vessels
13	Mechanical
15	Welding
17	Boiler and machinery miscellaneous

Open-Frame Rack Storage: Rack storage that is void of any solid shelves within the storage array and has adequate flue spaces to (1) allow rapid vertical fire growth (minimizing horizontal fire spread), and (2) allow downward sprinkler water penetration throughout the height of the rack. Open-frame rack storage allows water discharge to reach all vertical surfaces of a commodity.

For rack storage to qualify as open-framed it must:

- Have adequate transverse flue spaces throughout the height of the rack at maximum of every 9 ft (2.7 m) horizontally, and
- Be void of blocked transverse flue spaces.

Open-frame racks can be equipped with solid shelves provided that

- The solid shelves are fixed-in-place, and
- Are no larger than 20 ft² (2.0 m²) in area, and
- Do not block transverse flue spaces.

Multiple-row racks void of any solid shelving can be considered open-frame when they are provided with minimum 6 in. (150 mm) wide vertically aligned longitudinal and transverse flue spaces roughly every 5 ft (1.5 m).

When multiple-row racks void of solid shelving are not provided with minimum 6 in. (150 mm) wide vertically aligned longitudinal flue spaces, they can still be considered as open-frame when:

- A. Minimum 6 in. (150 mm) wide vertically aligned transverse flue spaces are provided roughly every 5 ft (1.5 m), and
- B. The rack depth does not exceed 20 ft (6.1 m), and
- C. Minimum 8 ft (2.4 m) wide aisles define the depth of the multiple-row rack.

The storage racks can also be provided with grated shelves as long as the grating is at least 70% uniformly open, or they can be provided with fixed-in-place solid slats as long as adequate transverse flue spaces are provided between all pallet loads.

Treat rack storage of nested or pyramided rolled fabric storage on side, or rack storage of other products that can create large shielded areas with no chance for sprinkler water penetration as rack storage having solid shelves, depending on the total area of shielding and the degree of obstruction to water penetration.

If rack storage does not meet the guidelines above for open-frame rack storage, then it must be treated as if it has solid shelves. See the definition of solid shelves in this appendix.

Open-Top Containers: These are containers having at least one solid side, and open on top. Containers that have five sides will collect and hold up water that has been discharged from operating ceiling-level sprinklers thus delaying the water delivery down through the flue spaces where it is needed to either suppress or control the fire. Containers with less than five full-height sides redirect the discharged water from operating sprinklers so that the water delivery down through the flues is not uniform. Five-sided, open-top containers made of wood, cardboard, plastic, or other combustible material promote faster horizontal fire spread compared to closed-top combustible containers. Noncombustible open-top containers help promote faster horizontal fire spread if combustible containers are located below them within a storage rack. See Section 2.2.5.1 when open-top containers are present within a storage rack arrangement.

Palletized Storage: A storage arrangement that consists of product stored on pallets. Pallet loads are placed one on top of another with the bottom load located directly on the floor.

Pallets: Material handling aids upon which unit loads of commodity are placed to ease the transport of commodity from place to place (see Figure A-2). Pallets may be wood, metal, or plastic. Conventional pallets have stringers to accommodate lift trucks for handling unit loads. Slave pallets (less than 20 ft² [2.0 m²]) are special flat-bottomed pallets captive to a material handling system. See Data Sheet 8-1, *Commodity Classification*, to determine their impact on the commodity hazard rating, as well as Data Sheet 8-24, *Idle Pallet Storage*, for their required protection if they are being stored within the facility.

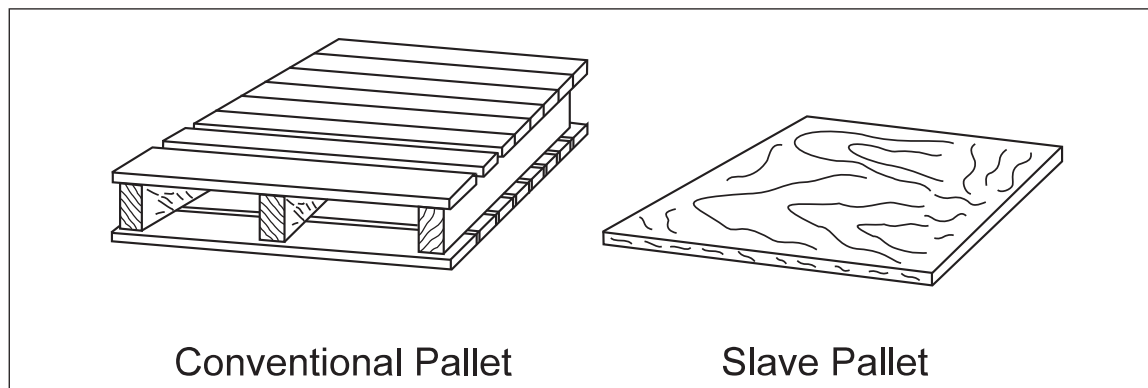

Fig. A-2. Typical wooden pallets

Portable Racks: Portable racks are not fixed-in-place. They can be arranged in any number of configurations, and include wire baskets without solid sides and bottoms and open-top containers without solid sides but with solid bottoms. Five-sided open-top combustible containers with solid sides and bottoms are treated as open-top combustible containers.

Rack Storage: Storage in racks that use combinations of vertical, horizontal and diagonal members, with or without solid shelves, to support stored material. Racks may be fixed-in-place or portable. Loading may be either conducted manually by using lift trucks, stacker cranes, or hand placement, or automatically by using machine-controlled storage and retrieval systems.

- Single-row racks have no longitudinal flue spaces, are up to 6 ft (1.8 m) deep and have aisles over 2 ft (0.6 m) wide.
- Double-row racks are two single-row racks placed back-to-back separated by a longitudinal flue space, with aisles over 2 ft (0.6 m) wide.
- Multiple-row racks are racks greater than 12 ft (3.6 m) wide, or single-row or double-row racks separated by aisles 2 ft (0.6 m) wide or less having an overall width, including flues, greater than 12 ft (3.6 m). Multiple-row racks can be drive-in, drive-through, flow-through, push-back or double-deep standard racks. The rack depth is the determinant.

Figures A-3 through A-11 show typical rack storage configurations.

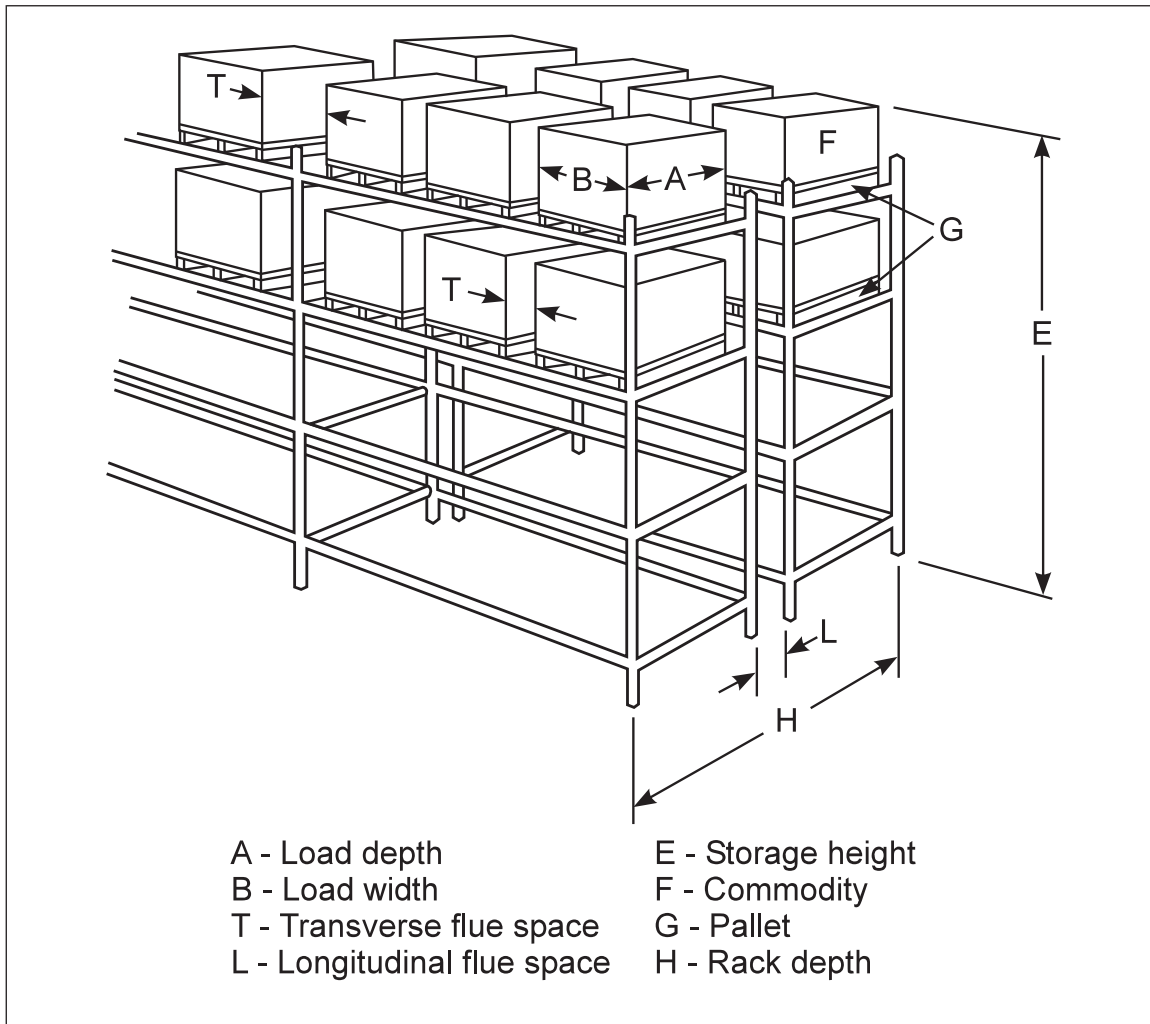

Fig. A-3. Open-frame double-row racks

Shelf Storage: Storage on a structure where solid shelves are less than 30 in. (0.8 m) deep, measured from aisle to aisle, and usually less than 2 ft (0.6 m) apart vertically.

Solid-Piled Storage: On-floor storage, without pallets or other material handling devices. Unit loads are placed on top of each other, leaving no horizontal spaces between unit loads.

Solid Shelving: Fixed-in-place, solid, slatted (fixed or non-fixed), grated (less than 70% open), or other types of shelves located within racks.

Solid shelving within storage racks can promote horizontal fire spread and negatively impact the amount of sprinkler water that can reach the entire vertical height of the rack.

The area of a solid shelf is defined by minimum net clear flue space width of 3 in. (75 mm) at all four edges of the shelf. A net clear flue space width is the gross width of the flue space minus the width of any obstruction (such as a rack upright). For example, 5 in. (125 mm) flues that have 2 in. (50 mm) wide horizontal rack members within the space would be acceptable because the net flue space width is 3 in. (75 mm).

See "Open-Frame Rack Storage" to determine whether a rack equipped with solid shelving can be considered open-frame for sprinkler system design purposes or if it must be treated as a rack with solid shelves. If the rack must be treated as having solid shelves, determine the area of the solid shelf as outlined above.

Storage Height: The measurement from the floor to the top of storage.

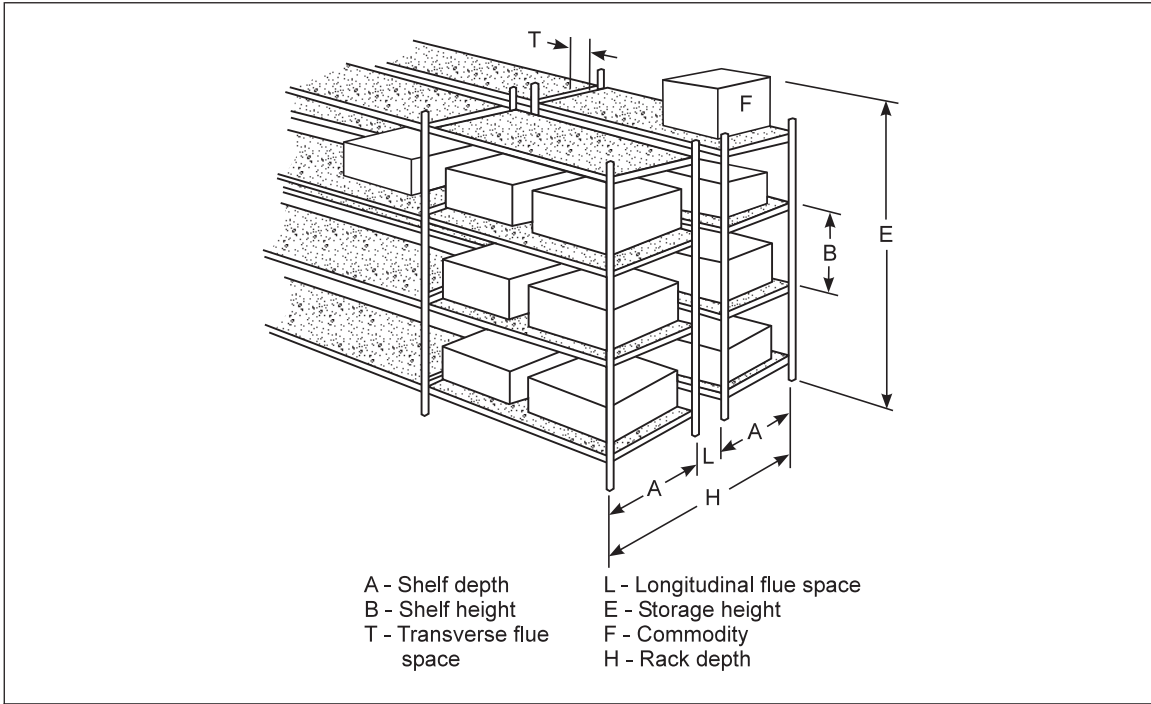

Fig. A-4. Double-row racks with solid shelves

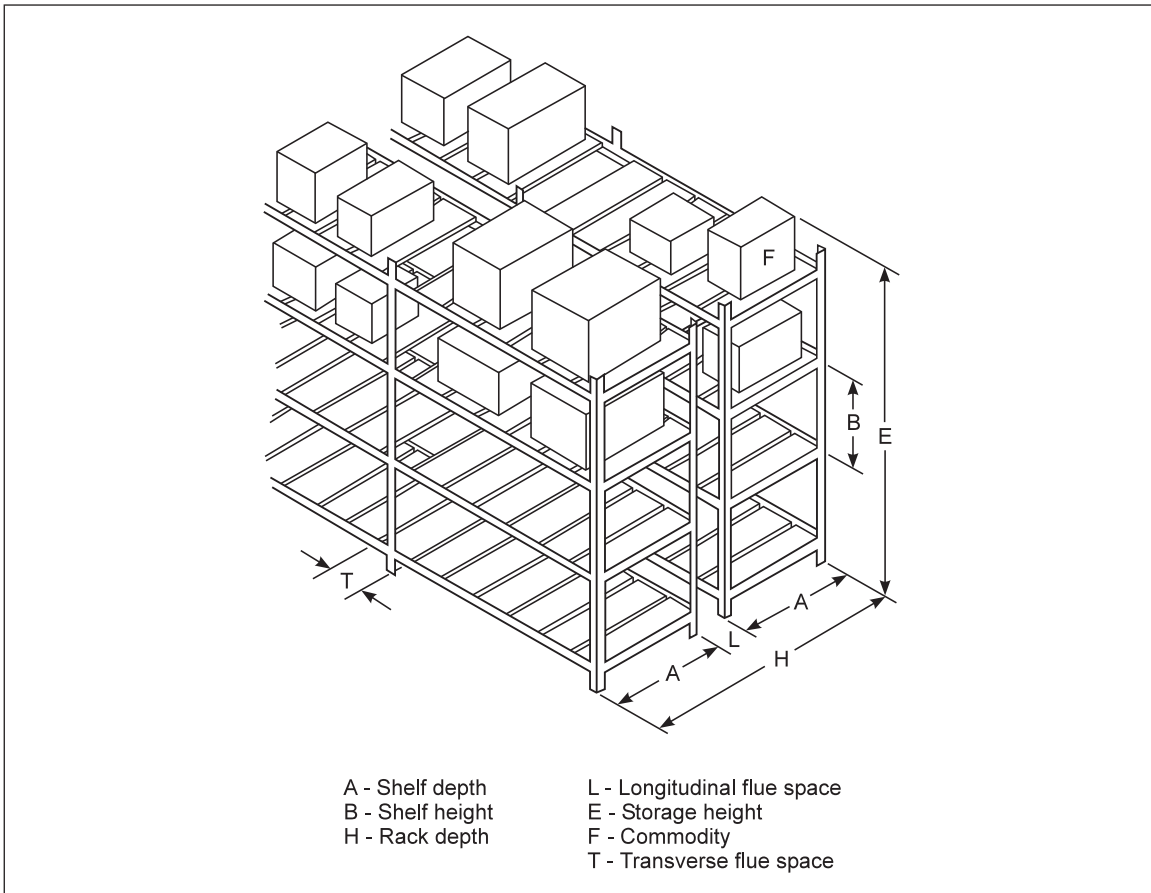

Fig. A-5. Double-row racks with slatted shelves

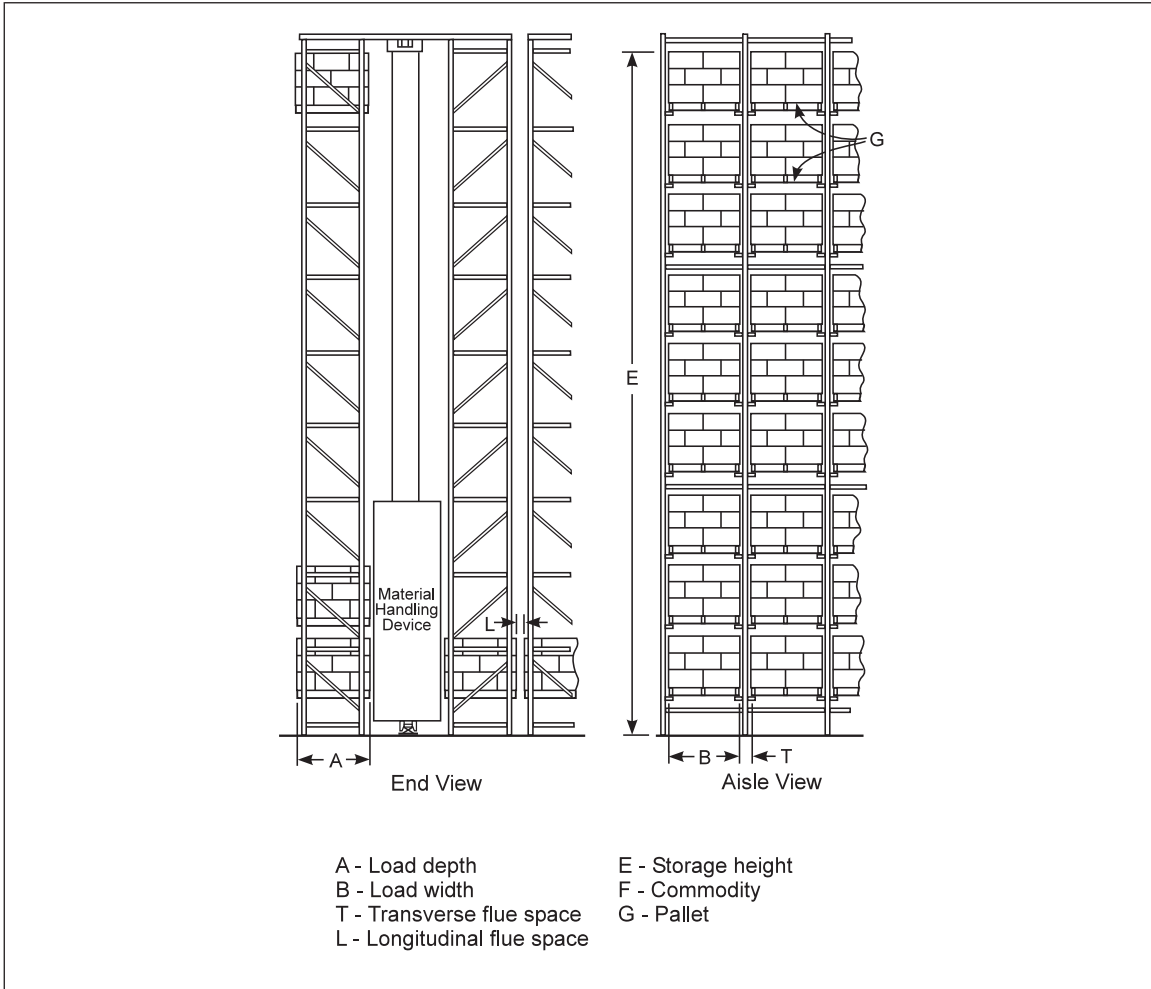

Fig. A-6. Automatic storage rack

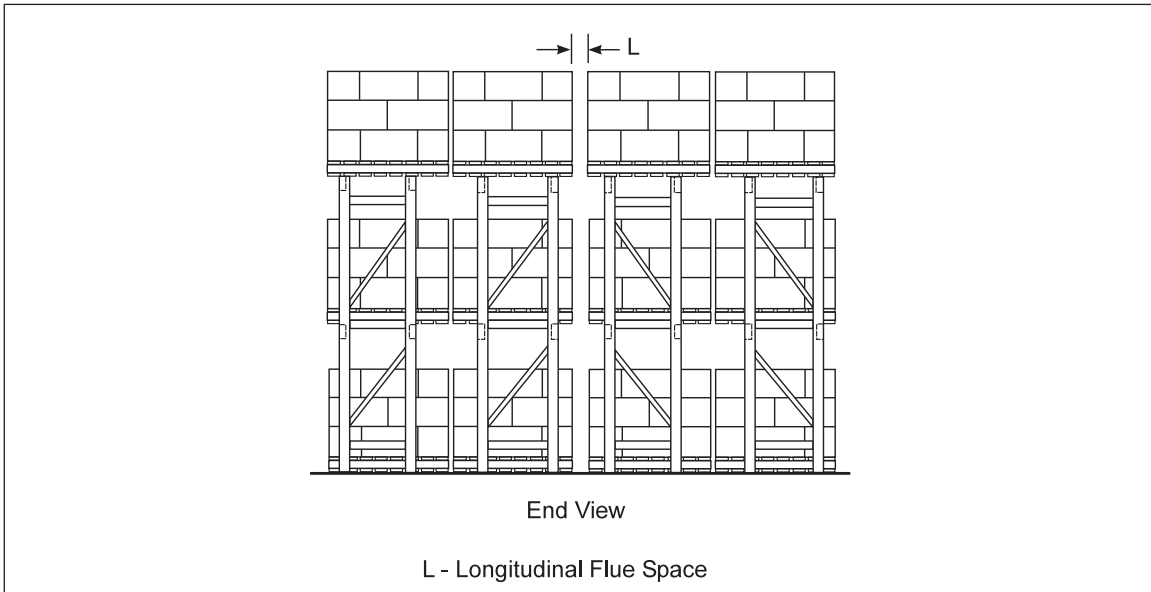

Fig. A-7. Multiple-row rack

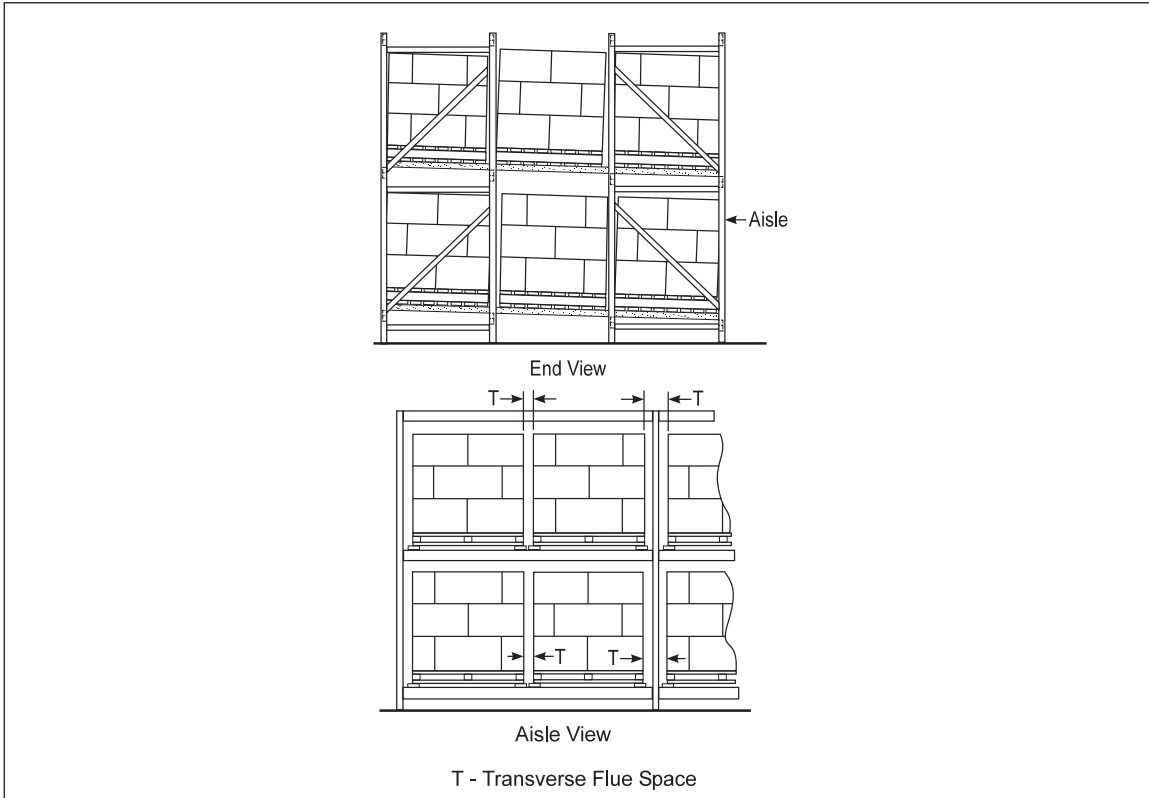

Fig. A-8. Flow-through pallet rack

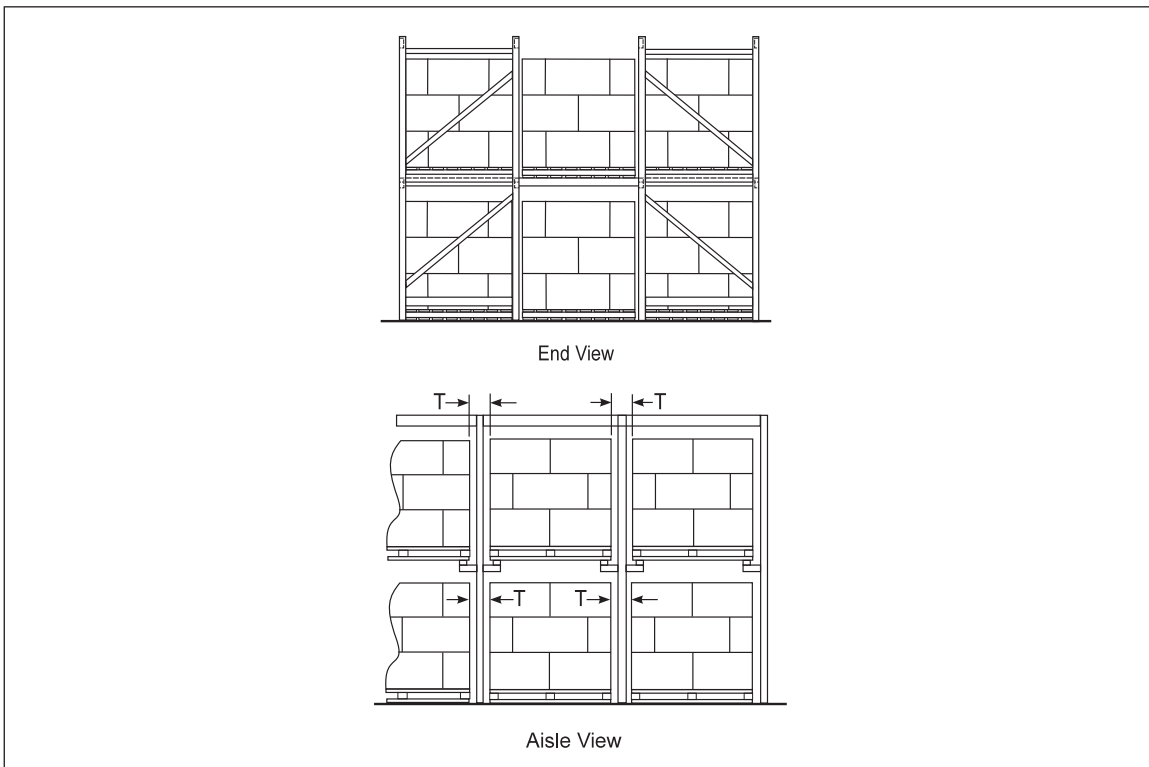

Fig. A-9. Drive-in rack, two or more pallets deep

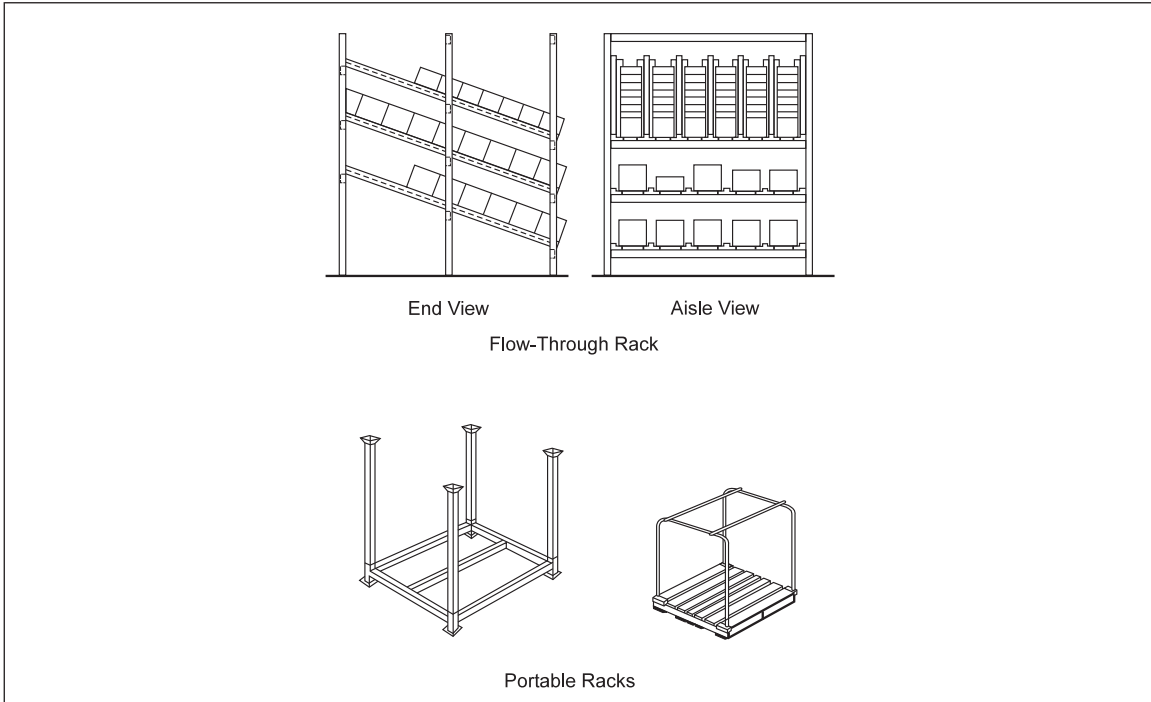

Fig. A-10. Flow-through and portable racks

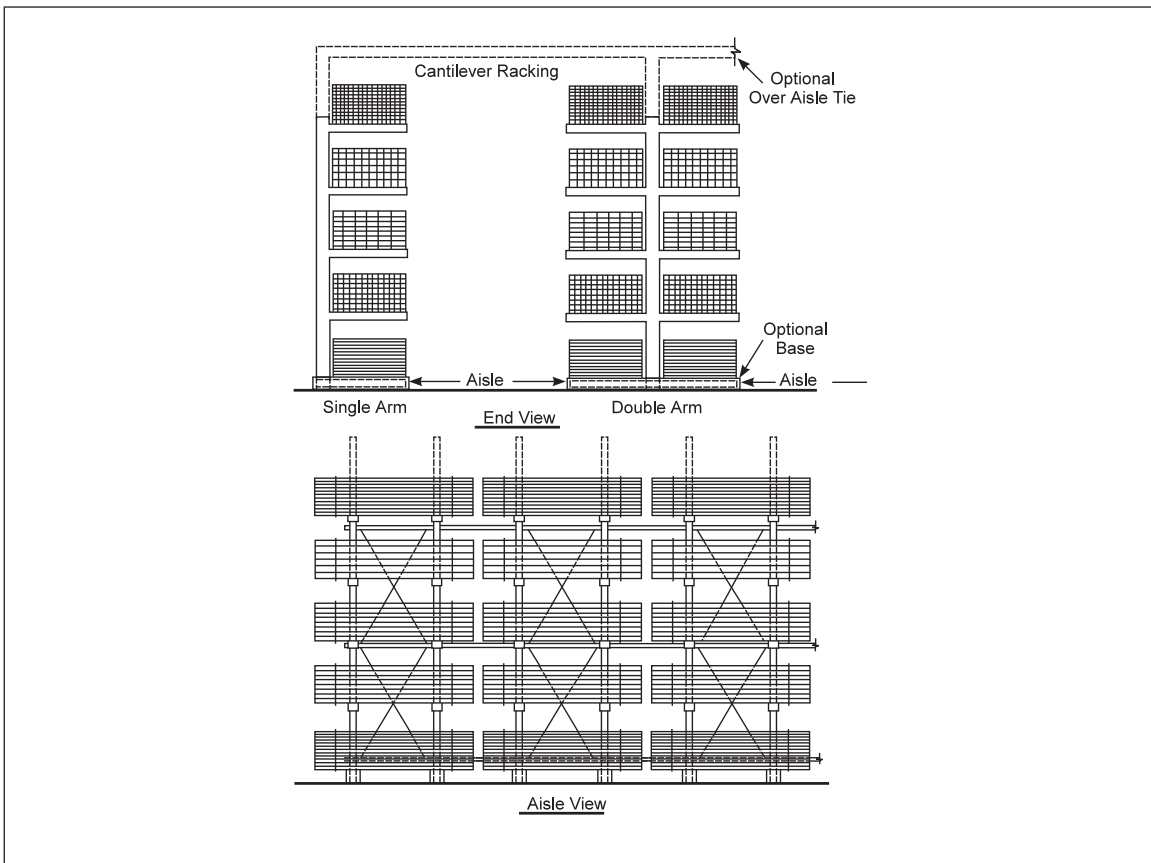

Fig. A-11. Cantilever rack

Tier: Each vertical segment of storage within a rack. The term “tier” is used only to define the vertical location for in-rack sprinklers when storage racks are equipped with solid shelves greater than 64 ft² (6.0 m²) in area.

Water Delivery Time: The time interval, measured in seconds, that is defined by the following two events:

- (1) The point in time when the most hydraulically remote sprinkler, or sprinklers, is opened on a dry-pipe, preaction, or similar type of sprinkler system equipped with an automatic opening system valve.
- (2) The point in time when the water pressure at the most remote sprinkler, or sprinklers, reaches and doesn't drop below the required design pressure for the sprinkler system.

See Figure A-12 for an example arrangement of an inspector's test connection using 2 sprinklers on the most remote branchline, or Figure A-13 for an example of an inspector's test connection using 4 sprinklers, 2 sprinklers on the most remote 2 branchlines.

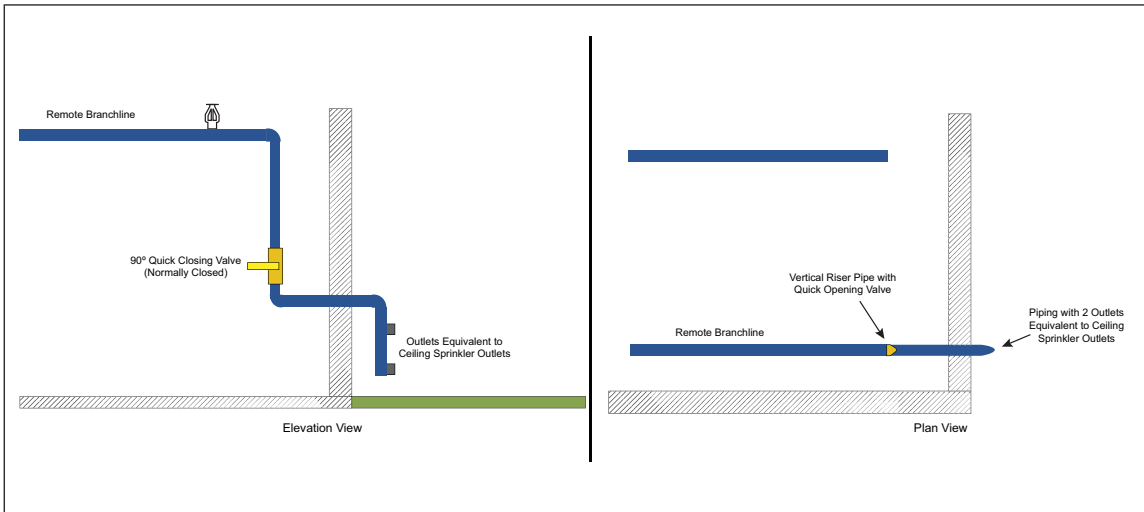

Fig. A-12. Example arrangement of an inspector's test connection for a dry sprinkler system design using 2 sprinklers on the most remote branchline

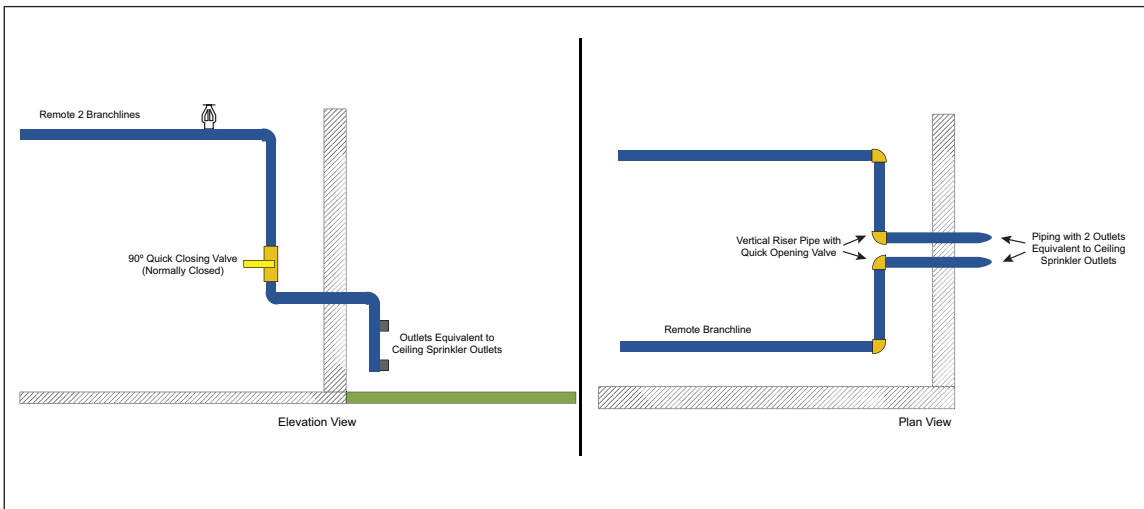

Fig. A-13. Example arrangement of an inspector's test connection for a dry sprinkler system design using 2 sprinklers on the most remote 2 branchlines (4 sprinklers total)

APPENDIX B DOCUMENT REVISION HISTORY

The purpose of this appendix is to capture the changes that were made to this document each time it was published. Please note that section numbers refer specifically to those in the version published on the date shown (i.e., the section numbers are not always the same from version to version).

October 2020. Interim revision. Significant changes to this edition of the data sheet include the following:

- A. Clarification was provided in Section 2.2.3.1.3 as to when longitudinal flue spaces are not required within double-row racks.
- B. The aisle width that defines the depth of a multiple-row rack not provided with longitudinal flue spaces was added to Section 2.2.3.1.5.
- C. Guidance regarding the maximum stored product overhang beyond a horizontal barrier was added to Sections 2.3.4.6.3 and 2.3.6.4 to be consistent with the guidance provided in Section 2.3.6.7.1(D).
- D. Tables 14a, 14b and 17b were updated to allow open-frame multiple-row racks, as defined in Sections 2.2.3.1.4 and 2.2.3.1.5, to be protected in accordance with their design options.
- E. The ceiling sprinkler protection options offered in Section 2.3.6.5 for both quick-response K14.0 (K200) and K16.8 (K240) pendent sprinklers were clarified when they are being used to protect the storage of uncartoned unexpanded plastics.
- F. The definition of open-frame multiple-row racks was updated in Appendix A to match the requirements indicated in Sections 2.2.3.1.4 and 2.2.3.1.5.

July 2020. Interim revision. Significant changes include the following:

- A. Updated protection Tables 2 through 11.
- B. Updated Table 13 to reflect the modifications made in protection Tables 7 through 11. In addition, the table was modified to include both the appropriate ceiling height for design purposes for the ceiling-level sprinklers in the presence of in-rack sprinklers, with a new column indicating which protection table to use.
- C. Modified Section 2.2.5.1.3 regarding in-rack sprinkler protection arrangements for open-top containers.
- D. Updated Section 2.2.3 to clarify recommendations for flue spaces.
- E. Added guidance in Sections 2.3.4.9 and 2.3.6.5 to clarify that the in-rack sprinkler systems for these protection options are intended to be on a wet-pipe sprinkler system.
- F. Modified Section 2.3.6.9 to address ceiling heights over 40 ft (12 m) (was 45 ft [13.5 m]).
- G. Updated Section 2.3.6.9 to include protection for on-floor storage of uncartoned unexpanded plastics up to a maximum storage height of 25 ft (7.5 m) under a maximum ceiling height of 45 ft (13.5 m).

January 2020. Interim revision. Data Sheet 8-9 was modified as follows:

- A. Table 1 was updated to include sprinkler spacing guidelines for quick-response, K28.0 (K400) pendent storage sprinklers.
- B. The information previously provided in Sections 2.3.6.9.1 and 2.3.6.9.2 has been combined and is now provided in Section 2.3.6.9.
- C. Table 17b was modified based on recent testing with quick-response K28.0 (K400) and K33.6 (K480) pendent storage sprinklers. In addition, the sprinkler designs within Table 17b were updated.

October 2019. Interim revision. Minor editorial changes were made.

July 2019. Interim revision. A new Section 2.3.6.9 has been created to address the installation and design guidelines for ceiling-only protection options involving ceiling heights of 50 ft (15 m) and 55 ft (16.5 m).

July 2018. Interim revision. A new Section 2.3.6.8 has been created to address the installation and design guidelines for protection scheme using quick-response K25.2EC (K360EC) pendent sprinklers as in-rack sprinklers in combination with horizontal barriers to protect open-frame rack storage of commodity hazards up to and including cartoned unexpanded plastics when the in-rack sprinkler protection was installed 30 ft (9.0 m) above floor level.

January 2018. Interim revision. The following changes were made:

A. Section 2.2.5.1 regarding open-top containers was revised to (1) remove the option where containers could be mixed within storage if they did not extend into the transverse flue spaces, (2) remove the option of placing a flat or domed-shaped fixed-in-place lid over the top tier of storage, and (3) clarify the in-rack sprinkler arrangement needed in the presence of open-top combustible containers. Due to these changes, Section 2.3.4.6.3.1 was also modified.

B. Section 2.3.6.1 was modified to incorporate all of the ceiling-only protection design guidelines for Class 1, 2 and 3 commodities under ceilings that are over 30 ft (9.0 m) protected by dry-pipe and similar sprinkler systems. Both Tables 2 and 7 were modified as part of this revision.

C. Protection guidelines for the newly FM Approved standard-response, standard-coverage, 280°F (140°C) nominally rated K33.6 (K480) upright sprinkler were incorporated into Section 2.3.6.1.

D. Figures 10 through 14 were modified to clarify where in-rack sprinklers are needed horizontally within a storage rack structure.

E. The footnotes in Tables 4, 6, 9, and 11 regarding the Tyco TY9226 sprinkler have been removed.

F. The guidelines in Table 6 for the quick-response, upright K14.0 (K200) and K16.8 (K240) sprinklers were revised.

June 2015. Interim revision. The following changes were made:

- Added a new section (2.3.6.6) on in-rack sprinkler protection based on recent testing
- Added a new section (2.3.6.7) on a potential in-rack sprinkler retrofit protection option for uncartoned unexpanded plastics stored in open-frame double-row racks
- Incorporated Engineering Bulletins 06-11 and 07-12
- Modified the designs for K11.2 (K160) and standard-response K16.8 (K240) upright sprinklers so the pressure values represent the values that were tested
- Modified Tables 2, 3, 7 and 8 based on recent testing of the quick-response K22.4 (K320) pendent sprinkler
- Modified the dry system designs in Table 5 so they are consistent with Table 10
- Modified the protection options in Tables 5, 6, 10 and 11 for both the quick-response K22.4 (K320) pendent and quick-response K25.2 (K360) pendent sprinklers based on recent testing
- Modified the hose and duration requirements for Scheme 8-9A
- Clarified guidance in Sections 2.3.2.5, 2.3.3.7.2.3 and 2.3.3.7.3.1

January 2011. Clarifications were made in Section 2.3.3.7.2, *Ceiling-Level Design Guidelines*.

September 2010. This data sheet has been revised to incorporate the following changes:

- The footnote regarding the Tyco TY9226 sprinkler was inadvertently left out of the March 2010 version of Data Sheet 8-9. It has been added back into this data sheet and is found at the bottom of Tables 4, 6, 9 and 11.
- Table 1 was modified to show a reduced linear and area spacing for K25.2EC (K360EC) sprinklers when the ceiling height exceeds 30 ft (9.0 m) and the protection is based on ceiling-only designs
- The ceiling-level design for the K25.2EC (K360EC) pendent quick-response sprinkler for ceiling heights up to 35 ft (10.5 m) was modified in Tables 2, 3, 7 and 8 from 6 sprinklers to 8 sprinklers.
- The ceiling-level design for the K25.2 (K360) pendent standard-response sprinkler for ceiling heights of 25 ft (7.5 m) and 30 ft (9.0 m) was modified in Table 8 from a pressure of 15 psi (1.0 bar) to 10 psi (0.7 bar).
- The ceiling-level designs for the K25.2EC (K360EC) pendent and upright quick-response sprinkler for ceiling heights up to 25 ft (7.5 m) were modified in Tables 2, 3, 4, 7, 8 and 9. In addition the ceiling-level design for this sprinkler was also changed in Table 4 for a ceiling height of 30 ft (9.0 m).

March 2010. This data sheet has been revised to incorporate the following changes:

A. The protection tables have been reorganized into five categories based on the following commodities:

1. Class 1, Class 2, and Class 3 commodities
2. Class 4 and Cartoned Unexpanded Plastic commodities
3. Cartoned Expanded Plastic commodities
4. Uncartoned Unexpanded Plastic commodities
5. Uncartoned Expanded Plastic commodities

B. The terms “Control Mode Density Area (CMDA) sprinkler,” “Control Mode Specific Application (CMSA) sprinkler,” and “Suppression Mode sprinkler” have been replaced with the term “Storage sprinkler.” This new terminology allows for the following changes:

- Only sprinklers considered acceptable for the protection of the commodities addressed in this data sheet, either at ceiling level or within storage racks, are listed as protection options.
- All ceiling-level sprinkler protection options for a given commodity and storage arrangement are listed in a single protection table.
- All ceiling-level sprinkler protection options are based on a single design format (i.e., number of sprinklers @ minimum operating pressure).

C. The following parameters are no longer considered when determining protection options:

- Storage height
- Aisle width
- Favorable and Non-Favorable factors

D. Section 2.2.5.1 on open-top combustible containers has been modified and now also addresses when open-top noncombustible containers need special consideration.

E. The maximum recommended flow for a K5.6 (K80) in-rack sprinkler has been increased to 30 gpm (115 L/min).

June 2009. Minor editorial changes were made for this revision.

January 2009. Corrections were made to Table 2.3.7.5(b). Also, corrections were made to the metric demand areas in Table 2.3.7.3(l), CMDA Sprinklers Installed on Dry System for Rack Storage up to 25 ft (7.5 m) of Uncartoned Expanded Plastic Commodities.

May 2008. Figure 2.3.4.2(d) was modified due to an editorial error.

January 2008. Combined the protection guidelines for Class 1 and 2 commodities protected by CMDA sprinklers into a single protection table.

Subdivided the protection tables for CMDA and CMSA sprinklers into those providing recommendations for wet-pipe sprinkler systems and those for dry-pipe sprinkler systems. As a result, it is no longer necessary to make an adjustment due to the presence of a dry-pipe sprinkler system.

Eliminated the need to interpolate for density and/or demand area within the CMDA protection tables.

Eliminated the need to adjust density and/or demand area values obtained from the CMDA sprinkler protection tables due to the presence of (1) dry-pipe sprinkler systems, (2) 160°F (70°C) temperature rated sprinklers, or (3) encapsulation.

Added a recommendation to use a nominal temperature rating of 160°F (70°C) for all ceiling-level sprinklers in wet-pipe sprinkler systems, and a nominal temperature rating of 280°F (140°C) for all ceiling-level sprinklers in dry-pipe sprinkler systems.

Added recommendation to base ceiling-level CMDA sprinklers on a minimum K-factor value of 11.2 (160). As a result, the minimum ceiling level density in all protection tables is 0.30 gpm/ft² (12 mm/min), based on a minimum sprinkler pressure of 7 psi (0.5 bar) and a maximum sprinkler area spacing of 100 ft² (9.0 m²).

Standardized the density values in the CMDA sprinkler protection tables to end in zero or five.

Created new terms for the various configurations of in-rack CMDA and CMSA sprinklers protecting rack storage up to 25 ft (7.5 m) high. They are defined as follows:

<i>Old Term</i>	<i>New Term</i>	<i>Meaning of New Term</i>
1 level IRAS	IRAS(EO)	One level of in-rack sprinklers spaced horizontally at every other transverse flue space
2 levels IRAS	IRAS(E)	One level of in-rack sprinklers spaced horizontally at every transverse flue space
3 or 4 levels IRAS	2 IRAS(E)	Two levels of in-rack sprinklers spaced horizontally at every transverse flue space
IRAS at every tier level	IRAS(ETL)	One level of in-rack sprinklers at every tier level spaced horizontally at every other transverse flue space

Provided new protection options in some CMDA sprinkler protection tables to either (1) increase density values (which lowers the size of the demand area), or (2) increase in-rack sprinkler arrangement values (which lowers the ceiling density value required).

As a result of recent testing, removed the recommendation allowing CMDA and CMSA sprinklers to be used at ceiling-only protection for rack storage of Class 4 and cartoned plastic commodities in buildings over 30 ft (9.0 m) high.

Removed the recommendation for steel column protection from CMDA sprinkler protection tables.

Added recommendation that in-rack sprinklers be quick-response type with a minimum K-factor value of 5.6 (80) for in-rack sprinkler flows less than 30 gpm (115 L/min) or K8.0 (K115) for in-rack sprinklers where the required flow is 30 gpm (115 L/min) or higher.

Added recommendation to provide longitudinal and face in-rack sprinklers for double-row racks over 9 ft (2.7 m) wide and up to 12 ft (3.6 m) wide.

Modified most of the figures representing the location of in-rack sprinklers. With the exception of Figure 2.3.7.3(h), they no longer show in-rack sprinkler arrangements incorporating vertical and/or horizontal stagger.

Removed uncartoned unexpanded plastic commodities from the in-rack protection schedule shown in Figure 2.3.7.3(g).

Added figures representing the location of both single-row and double-row in-rack sprinklers for storage racks up to 25 ft (7.5 m) high.

Changed the term "Scheme A" to "Scheme 8-9A" in order to avoid confusion with the in-rack protection layout called "Scheme A" in Data Sheet 7-29, *Flammable Liquid Storage in Portable Containers*.

Replaced the protection options previously provided in the suppression mode sprinkler protection tables for 32 ft (9.6 m) high ceilings with protection options based on 35 ft (10.5 m) high ceilings.

Added recommendation that the maximum width of a flue space be 24 in. (0.6 m). As a result, the definition of an aisle has been revised to be a horizontal distance between two storage racks that is wider than 2 ft (0.6 m).

Enhanced the definition of bin-box storage.

Enhanced the definition of portable racks to indicate a portable rack with a solid bottom and three solid fixed-in-place noncombustible or wooden sides that will inhibit horizontal fire spread can be treated as a solid-piled storage arrangement with favorable factors.

Changed the definition of "tier" to refer to any vertical storage segment.

May 2006. Minor editorial changes were made for this revision.

January 2006. Revisions were made to Table 2.3.7.3(r).

September 2005. Revisions were made to the different tables.

May 2005. Revisions were made to the Table 2.1.2(a).

January 2005. Minor editorial changes were made for this revision.

Changes made in the September 2004 revision include:

8-9 Storage of Class 1, 2, 3, 4 and Plastic Commodities

Terminology for Sprinklers: FM Approvals now uses four separate categories of sprinkler type, three of which are now utilized in this version. They are Suppression Mode (formerly referred to as ESFR), Control Mode Specific Application (formerly referred to as Large-Drop) and Control Mode Density Area (formerly referred to as Standard) sprinklers.

Due to the number of new sprinkler types now available for use, the protection tables have been reformatted based on sprinkler type, as well as commodity hazard and storage arrangement. The reformatting of the protection tables lead to a reorganization of the data sheet with subsections now based on sprinkler type rather than storage arrangement.

Protection options for Plastic commodities no longer take into account Group type, but simply whether they are unexpanded or expanded, and whether they are cartoned or uncartoned. In addition, reference to polyurethane plastic and rubber have also been removed from the data sheet as Data Sheet 8-1, Commodity Classification, addresses how to classify the hazard they present.

The protection options for Shelf storage are now grouped with Bin-Box storage rather than Solid-Piled and Palletized storage. In addition, Shelf storage and Bin-Box storage are considered to have inherently Favorable Factors, regardless of the type of Plastic commodity. As a result, Favorable Factors has to be determined as "Yes" or "No" only for Plastic commodities maintained in either a Solid-Piled or Palletized storage arrangement and protected by Control Mode Density Area sprinklers.

The protection tables for Control Mode Density Area sprinklers protecting rack storage over 25 ft (7.5 m) high have been modified in several ways. There are now nine protection tables instead of two, with each table specific to the rack type (SRR, DRR or MRR) and the size of the shelving present (open, 20-64 ft², or greater than 64 ft²). As a result, Table 3.3.7.3(AA), 20 to 64 ft² (1.9 to 5.9 m²) Solid Shelves, has been eliminated. Other modifications to the protection tables include (1) the tables no longer include columns for IRAS Face and Longitudinal Flue Spacing or IRAS Stagger, (2) instead of a Note that indicates possible adjustments to the table's indicated density, the tables now provide the density and demand area for storage heights either (a) up to 5 ft (1.5 m) above the top level of in-rack sprinklers or (b) over 5 ft (1.5 m) and up to 10 ft (3.0 m) above the top level of in-rack sprinklers, (3) for a given height of storage above the top level of in-rack sprinklers, the density requirements for all three storage arrangements are now the same.

The figures representing in-rack sprinkler spacing and location for rack storage over 25 ft (7.5 m) high protected by Control Mode Density Area sprinklers have been modified as follows, (1) each figure is specific to both the rack type and the shelving size, (2) the in-rack sprinklers shown in each figure's Plan View are now represented at the intersection of the transverse flue spaces, and (3) information regarding the in-rack sprinkler's spacing and location is now provided as a Note on the figure.

Reference for earthquake protection of both storage racks and sprinkler systems has been added to the data sheet.

Comparisons to other standards, such as NFPA, have been deleted. As a result, Section 5.4, National Fire Protection Association (NFPA) Standards, has been eliminated.

Metric values provided in this version of the data sheet have been modified, as needed, so they are now based on "realistic" and "design desired" values instead of strict mathematical conversion values.

New protection options have been provided within the protection tables for all storage arrangements involving Control Mode Specific Application sprinklers to account for excessive clearance. In addition, new protection options have been provided within the protection tables for solid-piled, palletized, shelf and bin-box storage arrangements protected by Control Mode Density Area sprinklers to account for excessive clearance.

In an effort to simplify the options available to the user, new supporting tables have been created for the hazard associated with Open-Top Combustible Containers (all sprinkler types) and Excessive Clearance (Control Mode Density Area). In addition, two new options have been added to the new Excessive Clearance table to help account for excessive clearance involving Control Mode Density Area sprinklers.

A new supporting table has been created that provides the required density and demand area for ceiling-level Control Mode Density Area sprinklers when extra levels of in-rack sprinklers are provided. This table replaces the previous Table 3.3.7.2(AA), Ceiling Sprinkler Density Adjustments, which provided guidelines on how to adjust the density obtained from a protection table. As a result, an adjustment to the existing density obtained from the protection tables is no longer necessary due to the presence of extra levels of in-rack sprinklers.

The wording previously listed in Section 3.3.4, In-Rack Sprinklers (IRAS), has been amended to stress the critical importance of locating the in-rack sprinklers at the intersection of flue spaces as well as providing a proper stagger for multiple in-rack sprinkler levels in the absence of horizontal barriers.

The protection option known as "Scheme A" from Data Sheet 7-29 has been incorporated into this version of the data sheet as a means of isolating and protecting small amounts of high hazard commodities that cannot be protected by the existing or proposed sprinkler systems. The design provided in Data Sheet 7-29 has been modified for this data sheet as follows: (1) the number of in-rack sprinklers flowing is based on 6 sprinklers if the rack to be protected with Scheme A protection is single-row, or 8 sprinklers if the protected rack is double- or multiple-row; (2) the number of in-rack sprinklers in the design is not tied to a number of sprinklers flowing on 2 lines; (3) the design is based on a minimum flow of 60 gpm (230 L/min) instead of 50 psi (3.5 bar); and (4) the use of FM Approved K11.2 (K160) quick-response sprinklers are permitted in addition to FM Approved K8.0 (K115) quick-response sprinklers.

The minimum operating pressure for all Control Mode Density Area sprinklers is now 7 psi (0.5 bar).

The horizontal and vertical spacing for in-rack sprinklers is now consistent throughout the data sheet regardless of storage height or aisle width.

The previous Section 3.3.7.2.3, Special Procedure for Evaluating Existing Systems Using Standard or ELO Sprinklers to Protect Class 1-4 Commodities and Which Have Ceiling Sprinkler Design Areas Other than 2000 ft² (186 m²) for Wet Pipe Systems, or 2,600 ft² (242 m²) for Dry-Pipe Systems (and Preaction Systems Treated as Dry-Pipe Systems), has been eliminated.

Table 3.3.7.4(AA), Suppression Mode (ESFR) Automatic Sprinkler Protection for Plastic Commodities, has been eliminated since the information it contained has been incorporated into the new protection tables.

Table 3.3.3.2, Extension Design Area for 286°F (141°C) Sprinklers, has been eliminated. The data sheet now recommends that the extension of the design and the sprinkler type protecting the area with the higher hazard be the same.

Tables 3.3.7.2, Rack Storage Up Through 25 ft (7.6 m) High, and 3.3.7.4, Solid-Piled, Palletized, Shelf and Bin-Box Storage, have been eliminated due to the reorganization of the data sheet.

Any information that is not specific to this data sheet and is covered in other FM Global data sheets has been eliminated. As a result, information previously provided in Sections 3.1.2, Roof Construction, 3.1.3, Roof Slope, 3.3.4.6, In-Rack Sprinkler Piping, 3.3.4.7, In-Rack Sprinkler Control Valves, 3.3.4.8, In-Rack Sprinkler System Size, 3.3.4.9, In-Rack Sprinkler System Waterflow Alarms and Test Connections, and Figure 3.3.4.7, Supply pipe arrangement to sprinklers at ceiling and in-racks, have been eliminated. In addition, the location requirements of heat detection for pre-action in-rack sprinkler systems has also been eliminated and replaced by the appropriate reference in other data sheets.

As a supplement to the two existing figures representing in-rack sprinkler protection for multiple-row rack storage up to 25 ft (7.5 m) high, two new figures were added. They include (1) a second option of in-rack sprinklers when the protection tables indicate that more than one level of in-rack sprinklers is required, and (2) a representation of the in-rack sprinkler arrangement when solid shelves greater than 64 ft² (6.0 m²) are present. In addition, Figure 2.3.4.2(b) has been modified so that all the "X" in-rack sprinklers are at the top of the second tier level and all of the "triangle" in-rack sprinklers are at the top of the fourth tier level, in order to reduce the cost of the installation to a FM Global client while at the same time offering the same level of in-rack sprinkler protection.

Former Figure 3.3.7.3(k), which is now Figure 2.3.7.3(l), has been clarified that it applies only to wet-pipe sprinkler systems.

Section 2.1.1, General, has been enhanced to include a recommendation for proper anchorage of the storage racks.

Table 2.1.3.1, Acceptable Types of Heat and Smoke Vents, has been modified to account for a new FM Approved drop-out heat vent that is acceptable in the presence of Suppression Mode sprinklers. In addition, the recommendation to provide an additional sprinkler under the center of a vent that cannot be equipped with a temperature link per Table 2.1.3.1 has been amended to say that the additional sprinkler should be quick-response.

The definition of "Flue Spaces" in Section 2.2.2 and Appendix A has been enhanced to include the minimum clear space needed in order to be considered acceptable for rack storage shelving purposes.

The requirement of longitudinal flue spaces for double-row racks over 25 ft (7.5 m) high has been eliminated from Section 3.2.2, Flue Spaces, Pile Stability, Product Spillage and Product Form. However, this is only permissible as long as there are no longitudinal flue spaces for the entire vertical height of the rack.

Portable racks were added to former Section 3.2.4 (now Section 2.2.4), Special Storage Considerations, and provided with additional guidance to define when they can be treated and protected as open-frame (multiple-row) racks.

The term "Single-Row Rack" was eliminated from any reference for racks wider than 9 ft (2.7 m) in Section 3.3.4.2.1, Open-Frame Racks with No Solid Shelves, since a single-row rack cannot be this wide.

Additional information has been provided in Section 2.3.7.3.4, Favorable vs. No Favorable Factors, to help better clarify the term Favorable Factors.

Section 2.0, General, has been deleted and the definition of terms has been relocated to Appendix A.

The section on Interpolation for Control Mode Density Area sprinklers has been modified to include an equation for interpolation.

The definition for "Aisle" in Appendix A has been enhanced to include the minimum acceptable width of 4 ft (1.2 m) so that it is consistent throughout the data sheet.

The definition for "Clearance" in Appendix A has been enhanced to include and define the term "excessive clearance".

The definition of "Rack Storage" in Appendix A has been modified so that a minimum distance of 4 ft (1.2 m) is now required to avoid single-row or double-row racks as being treated as multiple-row racks, the definition for portable racks has been enhanced to stress the need for acceptable flue spaces in order to be treated as open-frame (multiple-row) racks, grating must be a minimum of 70% to be considered open-frame, and slatted shelves that are not fixed-in-place automatically default to solid shelves.

The definition of "Rack Storage Sprinklers" in Appendix A has been enhanced to stress the importance of locating the sprinklers at the intersection of flue spaces and providing, when required, vertical stagger.

The definition of "Solid Shelving" in Appendix A has been enhanced to stress the need for openings at the transverse flue spaces in order to be considered open-frame racks.

Efforts were made to eliminate as many notes as possible from the protection tables.

May 2003. Minor editorial changes were made.

January 2003. Recommendation 3.3.3.5 Storage Clearance added.

September 2002. The following new sections have been added:

Section 3.3.8.5 was added to incorporate the guidelines for the K22.4 suppression mode sprinkler previously covered in Engineering Bulletin #06-01.

Section 3.3.8.6 was added to incorporate the guidelines for the newly Approved TYCO Model TY7126 K16.8 Upright Suppression Mode Sprinkler.

September 2001. In line with the changes described in Section 1.2, item 1, under "Changes made in the May 2001 Revision," the following changes are incorporated into the September 2001 version:

1. In Tables 3.3.7.2(a), (d), (g), and (j), in the ESFR column for all four storage heights and building height of 45 ft (13.5 m), replaced "12 @ 90 psi (6.1 bar)" with "DNA."
2. In Table 3.3.7.2(m), in the ESFR column for all four storage heights and building height of 45 ft (13.5 m), replaced "Note 13" with "DNA," and also deleted Note 13 that follows that table.

Note: "12 @ 90 psi (6.1 bar)" entries in Table 3.3.7.4(a) through (d) for solid-piled/palletized storage to 35 ft (10.5 m) in 45 ft (13.5 m) buildings remain valid as the change made in the May 2001 version applied only to rack storage.

May 2001. The following changes were made:

1. The guidelines in Section 3.3.7.3, item 1, part b for protecting storage of Class 1-4, and cartoned and uncartoned unexpanded plastic commodities in buildings over 40 ft (12.0 m) up to 45 ft (13.5 m) using K14.0 (K200) pendent suppression mode sprinklers at the ceiling only, have been rescinded as a result of recent

testing. Item 1, part C has been renumbered as part b. Storage of Class 1-4 and cartoned unexpanded plastic commodities in 45 ft (13.5 m) high buildings can be protected by K25.2 (K360) suppression mode sprinklers at the ceiling only as outlined in Section 3.3.8.1. There is no longer a method for protecting uncartoned unexpanded plastic storage in buildings higher than 40 ft (12.0 m) with suppression mode sprinklers at the ceiling only.

2. A new Section 3.3.8.4 has been added to incorporate the guidelines for the K16.8 (K240) suppression mode sprinkler previously covered in Engineering Bulletin #15-00.

3. A new Section 3.3.8.5 has been added to incorporate guidelines for the upright K14.0 (K200) suppression mode sprinkler previously covered in Engineering Bulletin #14-00.

May 2000. The following changes were made:

1. New text is added in Section 2.2.2.1 to address flue spaces blocked by rolls of fabric, fiber or other materials and that create a solid shelf effect.

2. Tables 3.3.7.2(i), (l), (o) and (r) are revised to recommend in-rack sprinklers for racks up to 10 ft (3.0 m) high that have solid shelves greater than 64 ft² (6.0 m²) and are used to store Class 3, 4 and plastic commodities.

3. New guidelines are added in Section 3.3.8.1 for K25.2 (K360) suppression mode sprinklers to protect uncartoned unexpanded plastic storage.

September 1999. The following changes were made:

1. Guidelines for K-factor 25.2 (360) suppression mode sprinklers and for K-factor 16.8 (240) CMSA sprinklers has been relocated to new Section 3.3.8.

2. Engineering Bulletin 5-99, "K-factor 25.2 Suppression Mode Sprinklers for Exposed Expanded Polystyrene and Polyurethane in Closed Array Palletized or Solid-Piled Storage," dated June 7, 1999, has been incorporated in Section 3.3.8.

March 1997. The following changes were made:

1. Guidelines for use of suppression mode sprinklers in buildings up to 45 ft (13.5 m) high have been added. Note the limits on storage height and commodity, and required design pressures as covered in the appropriate tables and text. Commodity is limited to cartoned and uncartoned unexpanded plastic or less, and storage height is limited to 35 ft (10.5 m) for palletized / solid-piled storage and open-frame rack storage without in-rack sprinklers, and to 40 ft (12.0 m) open-frame rack storage when one level of quick-response in-rack sprinklers are installed per data sheet guidelines.

2. Figure 3.3.7.3(k) and the associated Table 3.3.7.3(a) reference have been changed to allow 9 ft (2.7 m) wide racks to accommodate common non-North American rack designs and pallet dimensions.